

KHOSLA

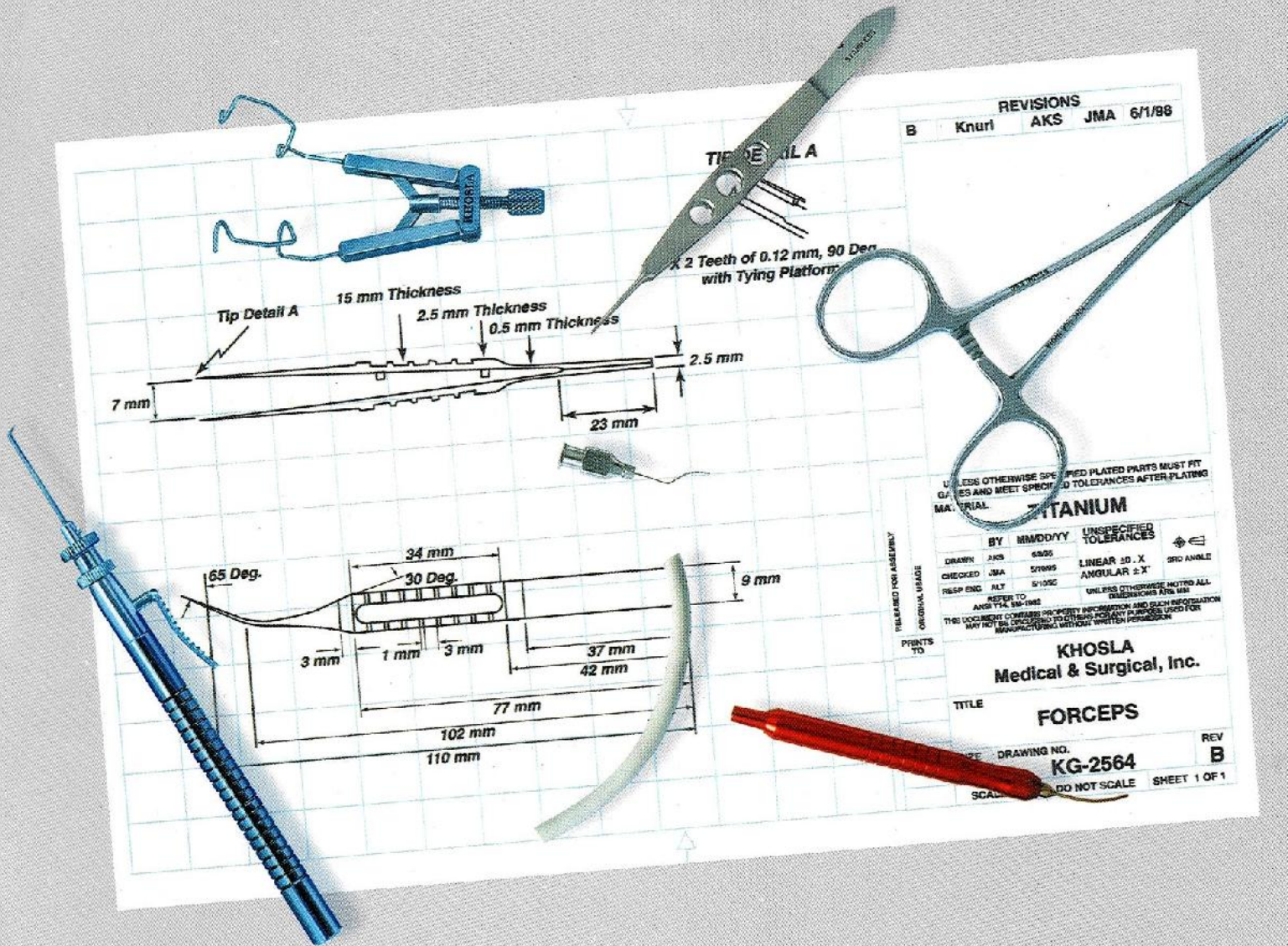

Eye Instruments



PRECISION & Quality



Khosla Eye Instruments

M/S. KHOSLA SURGICAL INDUSTRIES
SUDESH BUILDING, KENNEDY BRIDGE, NANA CHOWK, MUMBAI 400 007.INDIA.
TEL. NO.: 91-22-23875268 /23888603 FAX : 00-91-22-2380-5269
Email : khosla1@vsnl.com / neeru@khoslasurgicals.com
Website : www.khoslasurgicals.com

GENERAL INFORMATION

**all instruments shown in this catalogue are made
of Stainless Steel and Titanium**

Specifications are subject to change without notice.

Illustrations in this catalog are actual size except as note.

TABLE OF CONTENTS

S.NO	DESCRIPTION OF GOODS	PAGE NO.
1.	Titanium	1-10
2.	Vitreoretinal	11-13
3.	Rk/prk/lasik	14-19
4.	Bimanual Irrigation aspiration system	20
5.	Phaco Accessories	21
6.	Speculums	22-28
7.	Retractors	29-30
8.	Lid Retractors	31
9.	Iris Retractors	32
10.	Scleral Depressors	33
11.	Knives	34
12.	Spuds	35
13.	Muscle Hooks	36
14.	Iris Hooks	37
15.	Lens Manipulators	38-40
16.	Nucleus Rotators	41
17.	Phaco Choppers	42
18.	Spatulas	43-44
19.	Spatulas & Loops	45
20.	Loops	46-47
21.	Nucleus Splitters	48
22.	Spoons & Curettes	49
23.	Curettes & Cautery	50
24.	Cautery	51
25.	Calipers	52
26.	Lacrima	53-56
27.	Trephines	57
28.	Punches	58
29.	Rongeurs	59-60
30.	Forceps	61-84
31.	Forceps Bipolar	85
32.	Forceps Hoskin	86-87
33.	Scissors	88-98
34.	Needle Holders	99-102
35.	Blade Breakers	103
36.	Cannulas	104-111
37.	Trial Lens Sets	112-114
38.	Implants	115

39.	Eye Shield	116
40.	Sterilizing Trays	117
41.	Plastic sterilizing trays	118
42.	Disposable Blades	119-124
43.	Handles, Collects, Blades	125
44.	Microscope	126
45.	Slit lamp	127
46.	Keratometer	128
47.	Lensometer	129
48.	Vitreotomy i/a Unit	130
49.	Vitreotomy	131
50.	Cryo & i/a System	132
51.	Cryo	133-134
52.	Cryo Probes	135
53.	Bipolar coagulator	136
54.	Suggested Surgery Sets	137



K-1770/A Trephine 8mm & Alcohol Well 8.5mm
also available in trephine 9mm & Alcohol Well 9.5mm



K-1768 Micro-hoe and Epi-Peeler



K-1769 Flap Repositor

Nasal Speculum
for temporal Incision
KT-1058

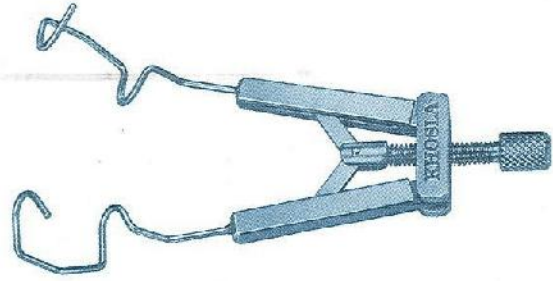

Temporal Speculum
for Regular Incision
KT-1059

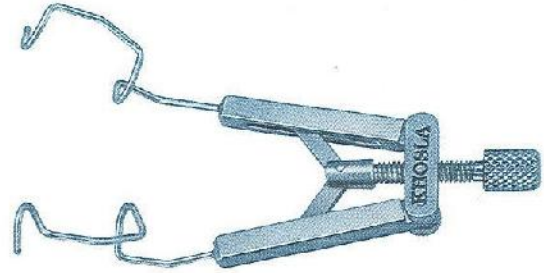

Solid Blade Speculum
for temporal Incision
KT-1060

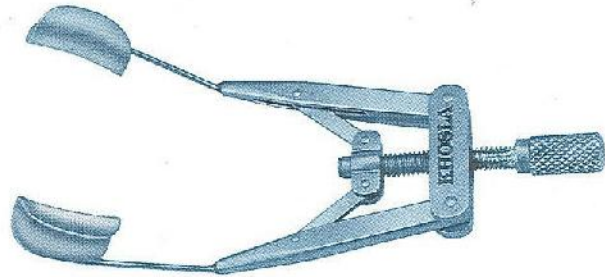

**Universal Reversible
Lid Speculum**
Can be used for both Regular
and Temporal Approach
KT-1061

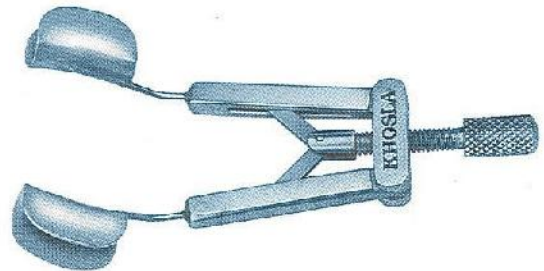

Nasal Speculum
with Aspiration
KT-1062

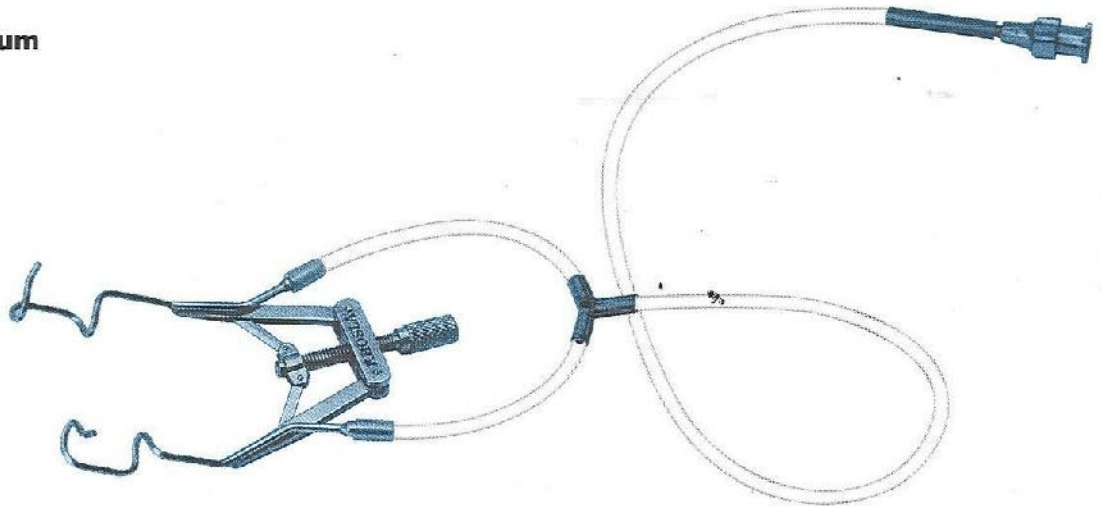

Temporal Speculum
with aspiration
KT-1063



KRATZ
Aspirating Speculum
KT-1064

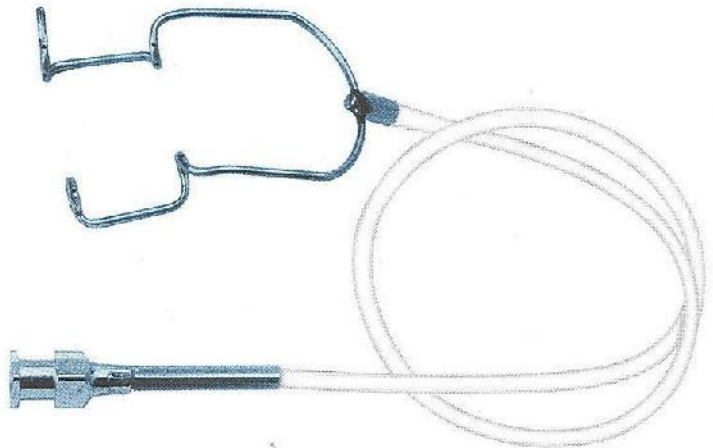

SINSKEY 11

Iris & lol Hook

KT-1632 Straight

KT-1633 Angled



KUGLEN

Iris Hook & Lens Manipulator

Clover look Tip

KT-1637/S Straight

KT-1637/A Angled



LESTER

Lens Manipulator

KT-1640/S Straight

KT-1640/A Angled



BECHERT

Nucleus Rotator

KT-1644/1 Angled, 7 mm.

KT-1644/2 Angled, 9 mm.

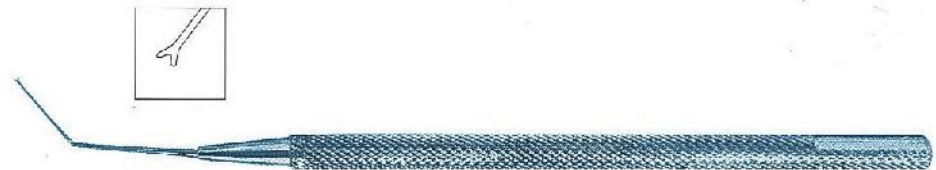

KUGLEN

Iris Hook & lens Manipulator

Push Pull model

KT-1656/S

KT-1656/A



LEWICKY

Lens Manipulator

KT-1658

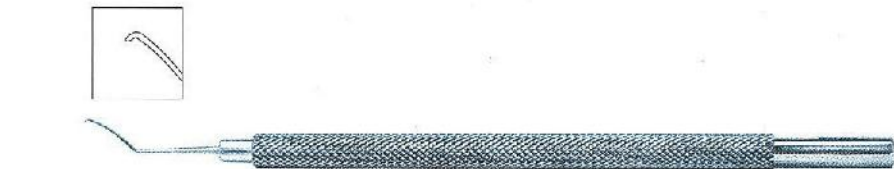

ROSEN
Phaco Chopper
KT-1739



NAGAHARA
Phaco Chopper
KT-1756

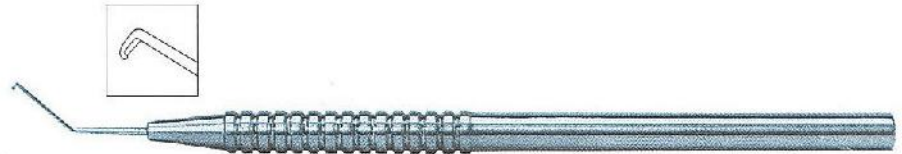

FUKASAKU
Small Pupil Snapper
Hook & Phaco Chopper
KT-1757



KOCH
Nucleus Divider
Strongly Curved Spatulated Tip
KT-1758



LIEBERMAN
Micro Finger
Nucleus manipulator
KT-1764



Nucleus sustainer
For Use with
phaco Chopper
KT-1765



BISHOP - HARMON

Iris Forceps 1 x 2 Teeth, 0.3 mm
KT-2517/A



CASTROVIEJO

Suture Forceps
KT-2562/A 0.12 mm Teeth
KT-2562/B 0.3 mm Teeth



CASTROVIEJO

Suture Forceps, 0.12 mm Teeth
KT-2564



BARRAQUER

Colibri Forceps, 0.12 mm Teeth
Delicate With Tying Platform
KT-2601



HARMS

Colibri Forceps, 0.12 mm Teeth
Delicate With Tying Platform
KT-2648



CASTROVIEJO

Colibri Forceps 0.12 mm Teeth
Delicate With Tying Platform
KT-2649



Mc PHERSON

Corneal Forceps, 1 x 2 Teeth, Straight
KT-2617



Mc PHERSON

Tying Forceps, Smooth Jaws, Straight
KT-2618



KELMAN-Mc PHERSON

Forceps, 8 mm Angled Jaws, Smooth
KT-2626

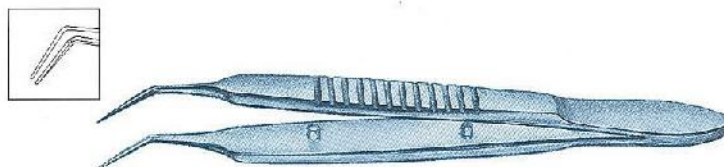

BECHERT-Mc PHERSON

Forceps, 11 mm Angled
Smooth Jaws, Delicate
KT-2662



HARMS-JAFFE

Tying Forceps
KT-2642/S Straight
KT-2642/C Curved



O'GAWA

Tying Forceps
KT-2668/S Straight
KT-2668/C Curved



BLAYDES

Iol Insertion Forceps

KT-2627

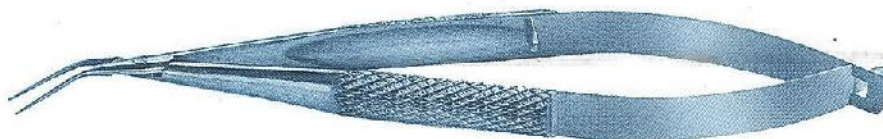

LIVERNOIS

Iol Holding and Folding Forceps
For Silicone Lenses

KT-2829



LIVERNOIS

Iol Holding Forceps
Smooth, Round highly polished Jaws
to avoid damage to the lens

KT-2830



IOL Inserting Forceps

For Acrylic and Silicone Lenses

KT-2831 Without Lock

KT-2832 With Lock



STEINERT

Universal Folding Forceps
For Acrylic and Silicone Lenses

KT-2839



FINE

Inserting Forceps
For Acrylic & Silicone Lenses

KT-2840





titanium instruments

KOCH
Universal Lens Folder
for Silicone Lenses
KT-2841

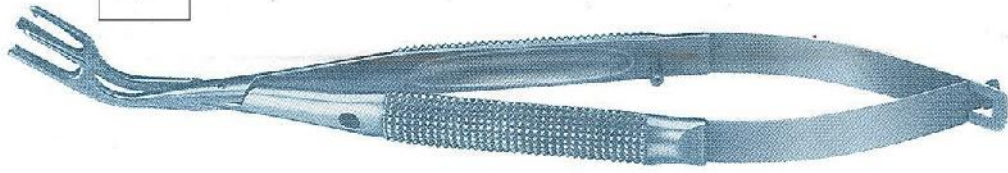

ERNEST
Nucleus Cracker
KT-2838

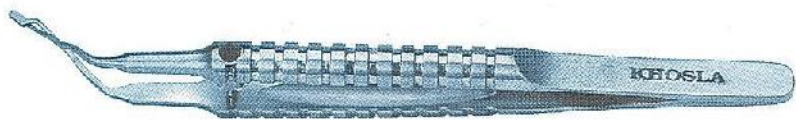

PRE CHOPPER
Sharp Tip Maximum opening 2.8mm
KT-2836/S Straight
KT-2836/A Angled



**PRE CHOPPER FOR
SOFT CATARACTS**
Angular Jaws help
Split Soft Nucleus
Very Sharp Tip
Opening 2.8mm
KT-2837/S Straight
KT-2837/C Curved
KT-2837/A Angled



UTRATA

Capsulorhexis Forceps
Cystotome Tips,
11mm Long Thin Jaws
Flat Handle

KT-2826

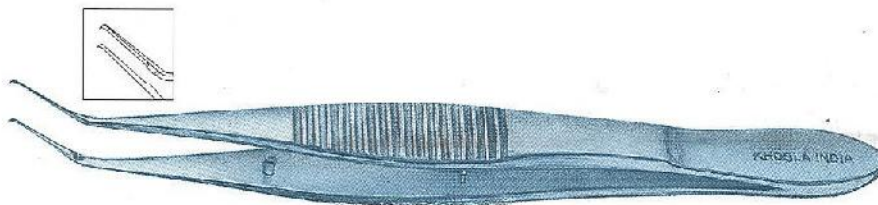

UTRATA

Capsulorhexis Forceps
Cystotome Tips
11mm Long Thin Jaws
Round Handle

KT-2827



MASKET

Capsulorhexis Forceps
Cystotome Tips
11mm Long Curved Jaws
3 - Hole Handle

KT-2828

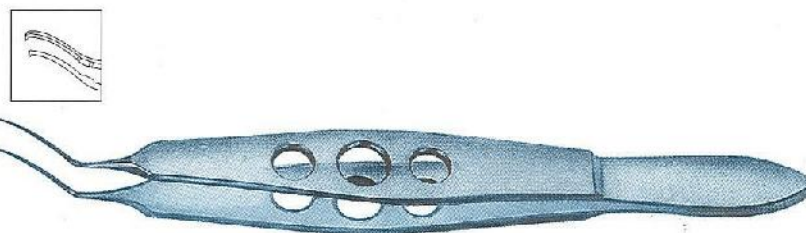

UTRATA

Capsulorhexis Forceps
Cystotome Tips
11mm Long Curved Jaws
Round Handle

KT-2834

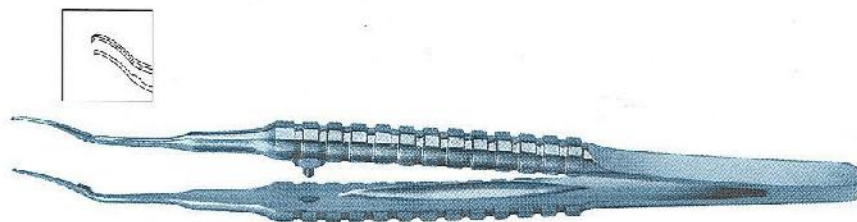

UTRATA

Capsulorhexis Forceps
Cystotome Tips
11mm Long Curved Jaws
Needle Holder Handle

KT-2835

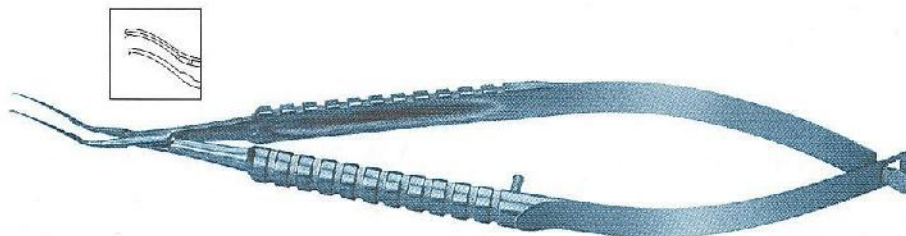

CASTROVIEJO

Needle Holder

Delicate Jaws, Straight

KT-3210/A With Lock

KT-3210/B Without Lock



BARRAQUER

Needle Holder

Very Delicate Smooth Jaws, Curved

KT-3227/CB

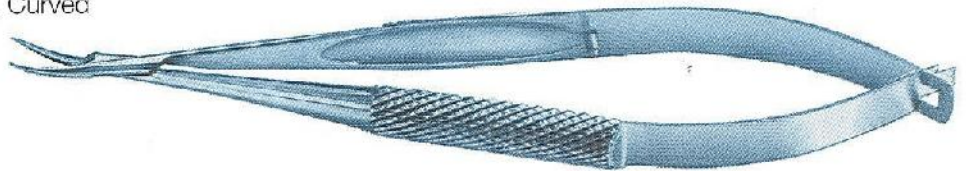

MICRO NEEDLE HOLDER

Finely Curved Delicate Jaws

KT-3245

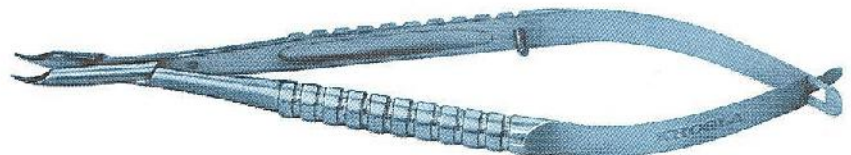

VITRECTOMY FORCEPS 20 G

K-2693 Vitreoretinal Handle with 3 interchangeable tips

Also available in titanium

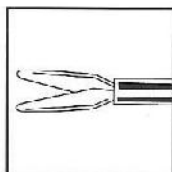

Smooth Jaws, Straight
KT-2685 (Titanium Handle)
K-2685 (Stainless Handle)



Serrated Jaws, Straight
KT-2686 (Titanium Handle)
K-2686 (Stainless Handle)

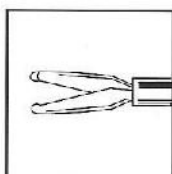

Smooth Jaws With
 Platform (End Gripping)
 Straight
KT-2687 (Titanium Handle)
K-2687 (Stainless Handle)

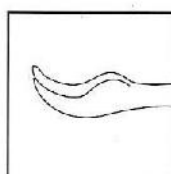

Smooth Jaws Curved
KT-2688 (Titanium Handle)
K-2688 (Stainless Handle)

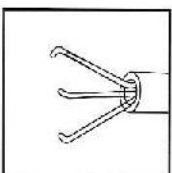

Vitreous Foreign
 Body Forceps
KT-2689 (Titanium Handle)
K-2689 (Stainless Handle)

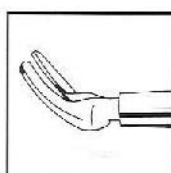

Membrane Dissector
 Curved
KT-2690 (Titanium Handle)
K-2690 (Stainless Handle)

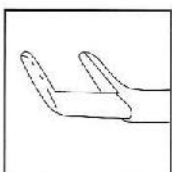

Intracocular
 Foreign Body Forceps
KT-2691 (Titanium Handle)
K-2691 (Stainless Handle)

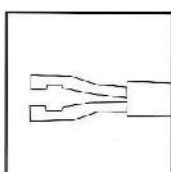

"PIC" Forceps
K-2692
 (Stainless Handle only)

VITRECTOMY SCISSORS 20 G

K-3144 Vitreoretinal Handle with 3 interchangeable tips
Also available in titanium

Vitreoretinal instruments

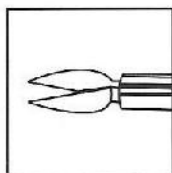
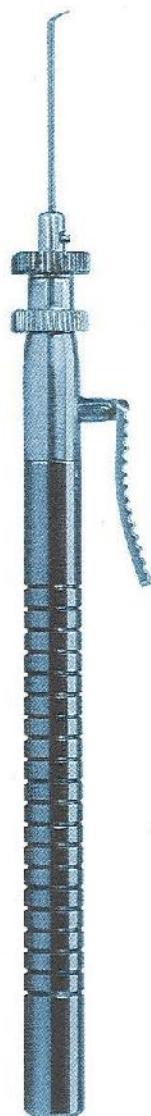

Horizontal Opening
Straight

KT-3137 (Titanium Handle)

K-3137 (Stainless Handle)

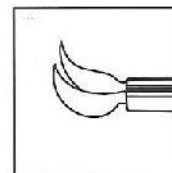

Horizontal Opening
Curved

KT-3138 (Titanium Handle)

K-3138 (Stainless Handle)

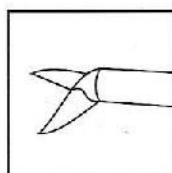

Horizontal Opening
Angled 55°

KT-3142 (Titanium Handle)

K-3142 (Stainless Handle)

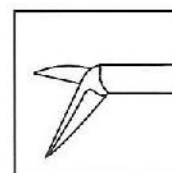

Horizontal Opening
Angled 70°

KT-3143 (Titanium Handle)

K-3143 (Stainless Handle)

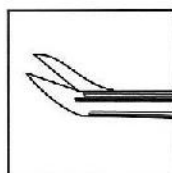

Vertical Opening
Angles 45°

KT-3139 (Titanium Handle)

K-3139 (Stainless Handle)

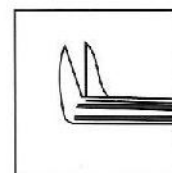

Vertical Opening
Angled 80°

KT-3140 (Titanium Handle)

K-3140 (Stainless Handle)

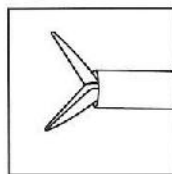

360° Rotatable Handle
Angled Upwards 45°

K-3141 (Aluminium Handle)

Retinal Membrane

Pick 110° Angled

K-1759



Retinal Spatula

0.5mm Triangular Tip

110° Angled

K-1760



Membrane Scratcher

With rake tip

K-1761



Membrane Peeler

K-1762



Membrane Spatula

Hooked

K-1763



Scleral Plug 20 g

K-2215



THORNTON

Low Profile Globe Fixation Ring
16mm Inner Diameter
K-5000



FINE-THORNTON

Fixation Ring
3/4 Open Ring with Swivel
150 Markings on Anterior
Surface for use in
Phaco Surgery & Limbal Incisions
K-5000/A 13mm diameter
K-5000/B 16mm diameter

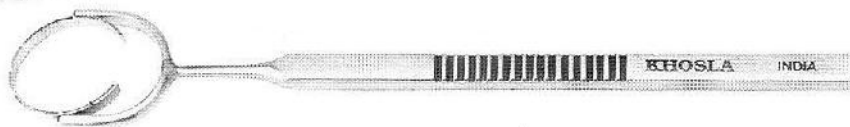
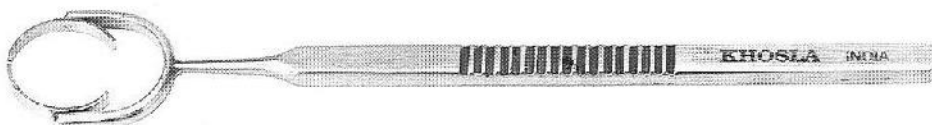

HOFMANN THORNTON

RK/AK Fixation Ring
Swivel Handle
K-5000/C 13mm diameter
K-5000/D 16mm diameter

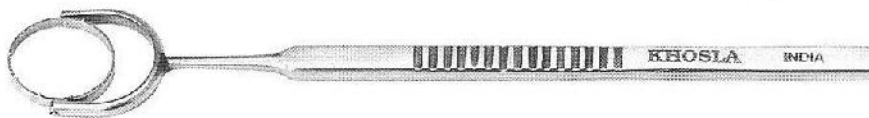

Globe Fixation Ring

for PRK and LASIK
12mm diameter
K-5101



Atraumatic Phaco

Fixation Ring
12mm diameter
K-5102

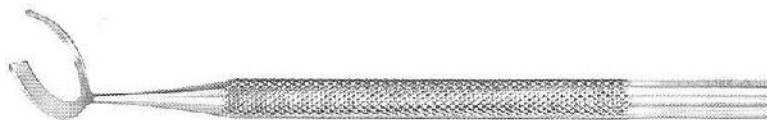

Atraumatic Phaco

Fixation Ring
3/4 open Ring with
swivel 12mm Inside Diameter 16mm outside Diameter
K-5104

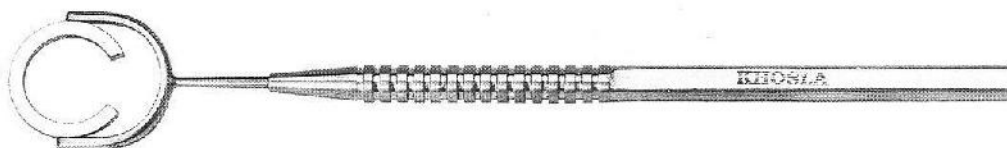

PATON
Spatula & Spoon for PRK
K-1732

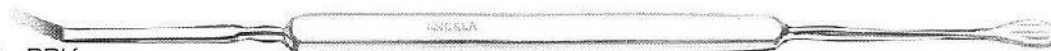

FUKASAKU
LASIK Spatula
for lifting & dissecting
the come of flap
K-5100



Hockey Knife
for PRK
K-5105



LASIK Spatula Double-ended
Flat Spatula for elevating the
flap on one end.
Round Cylindrical Spatula on opposite end for
repositing & smoothing the flap
K-5106

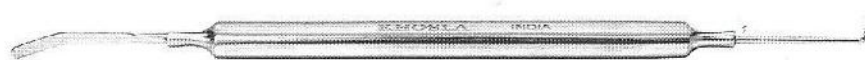

PETTIGROVE
PRK Marker / Spatula
K-5099



MALONEY
Intra-Operative Keratometer
for measurement of Astigmatism
KT-5103 Titanium only

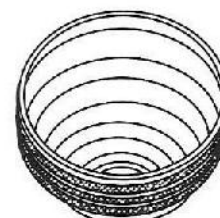

MENDEZ

Multi-Purpose LASIK Forceps
 To enter, dissect, elevate
 and smooth the flap
 Combined features of
 Spatula, dissector and forceps
K-5107



LASIK Flap Forceps
 Enables delicate lifting
 of the flap without causing trauma
K-5108

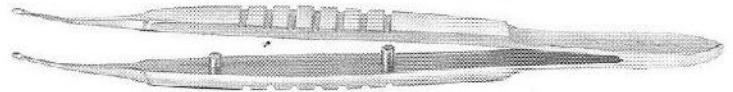

MENDEZ

Degree Gauge
 12mm Inner Diameter
K-5001



BORES

Axis Marker
 Used with Mendez Degree Gauge
K-5002

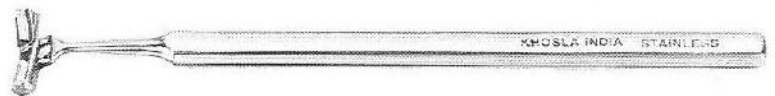

Osher-Newmann
 Corneal Marker
K-5005/A 4 lines
K-5005 6 lines
K-5006 8 lines
K-5007 12 lines
K-5008 16 lines



DEITZ
 Incision Depth Gauge
 For Corneal Incisions
K-5032 / 0.55mm



HOFFER

Optical Zone Marker
With Cross Hairs

- K-5010 2.50mm**
- K-5011 2.75mm**
- K-5012 3.00mm**
- K-5013 3.25mm**
- K-5014 3.50mm**
- K-5015 3.75mm**
- K-5016 4.00mm**
- K-5017 4.25mm**
- K-5018 4.50mm**
- K-5019 4.75mm**
- K-5020 5.00mm**
- K-5021 5.50mm**
- K-5022 6.00mm**
- K-5023 6.50mm**
- K-5024 7.00mm**
- K-5025 7.50mm**
- K-5026 8.00mm**
- K-5027 8.50mm**
- K-5028 9.00mm**
- K-5029 9.50mm**
- K-5030 10.0mm**

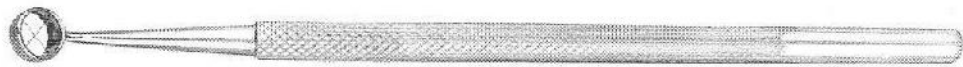

THORNTON

Optical Zone Marker
With Centering Pin

- K-5040 3.00mm**
- K-5041 3.25mm**
- K-5042 3.50mm**
- K-5043 3.75mm**
- K-5044 4.00mm**
- K-5045 4.25mm**
- K-5046 4.50mm**
- K-5047 4.75mm**
- K-5048 5.00mm**
- K-5049 6.00mm**
- K-5050 6.50mm**
- K-5051 7.00mm**
- K-5052 8.00mm**
- K-5053 9.00mm**



BORES

Optic Zone Marker

- K-5084 2.50mm**
- K-5085 2.75mm**
- K-5086 3.00mm**
- K-5087 3.25mm**
- K-5088 3.50mm**
- K-5089 3.75mm**
- K-5090 4.00mm**
- K-5091 4.25mm**
- K-5092 4.50mm**
- K-5093 4.75mm**
- K-5094 5.00mm**
- K-5095 6.00mm**
- K-5096 7.00mm**
- K-5097 8.00mm**

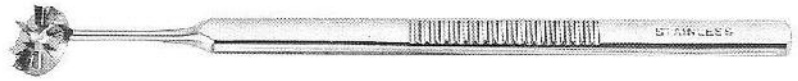

DOUBLE MARKER

3-5mm Diameter

K-5072



TRIPLE MARKER

3-5-7mm Diameter

K-5073



GRANDON

T-Incision Marker

K-5068/1 2.0mm Wide

K-5068/2 2.5mm Wide

K-5068/3 3.0mm Wide

K-5068/4 4.0mm Wide

K-5068/5 5.0mm Wide



KREMER

Corneal Fixation Forceps
With Lock, 13mm Spread

• 12mm Teeth

K-5061/S Straight

K-5061/C Curved

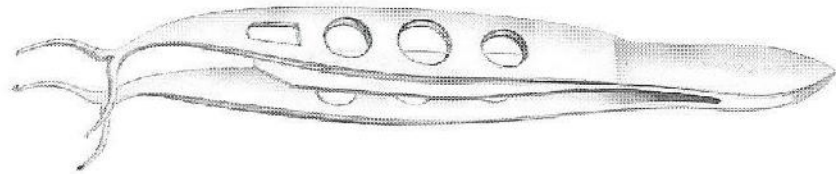

ARROW SMITH

Corneal Fixation Forceps
With Lock, 8mm Spread

12mm Teeth

K-5062/S Straight

K-5062/C Curved

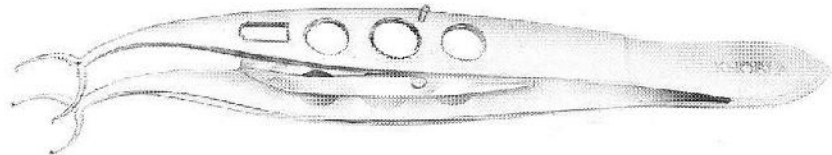

BORES

Corneal Fixation Forceps
3mm Spread, • 12mm Teeth

K-5063/S Straight

K-5063/C Curved





BIMANUAL Irrigation Aspiration System



Irrigation Handpiece 21 G
0.5mm Dual Sideports
KT-2273 Titanium Handle
KT-2273 Aluminium Handle

Aspiration Handpiece 21 G
0.4mm Port on Top
KT-2274 Titanium Handle
KT-2274 Aluminium Handle

Irrigation Handpiece 23 G
0.35mm Dual Sideports
KT-2279 Titanium Handle
KT-2279 Aluminium Handle

Aspiration Handpiece 23 G
0.35mm Port on Top
KT-2280 Titanium Handle
KT-2280 Aluminium Handle

Irrigation/Aspiration
Handpiece

K-2281

K-2281/S Straight

K-2281/C Curved

K-2281/45° Angul

K-2281/90° 90° Angled

K-2281/SI Simcoe

K-2281/B Binklorst

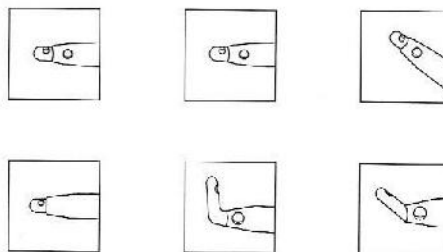
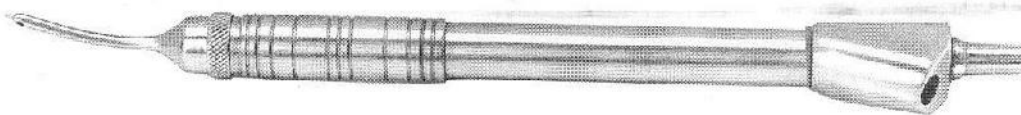

K-2282/15 15°

K-2282/30 30°

K-2282/45 45°

Curved Tip

K-2283 Tip 30° Curved 5°

K-2283 Tip 30° Curved 20°



Handpiece for
Phaco emulsification

K-2285

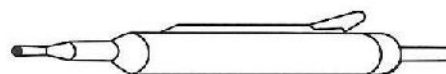

Irrigating Silicone Sleeve
Non Sterile-(pcs/pack)

K-2286

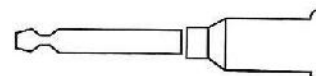



speculums

CRITCHETT
Eye Speculum
K-1001

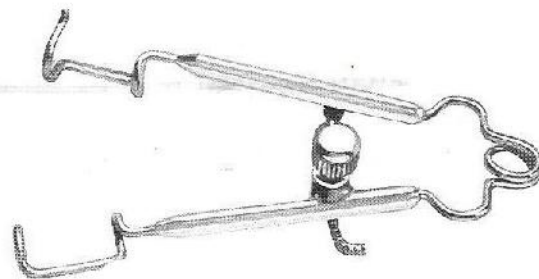

WEISS
Eye Speculum
K-1002

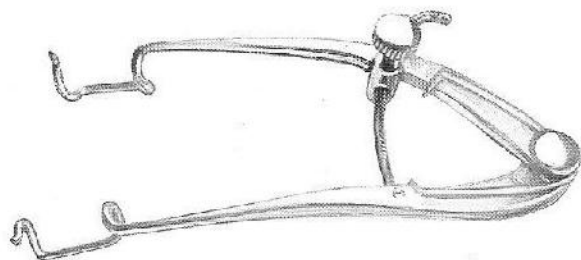

WILLIAMS
Eye Speculum
K-1004/1 Child Size
K-1004/2 Adult Size

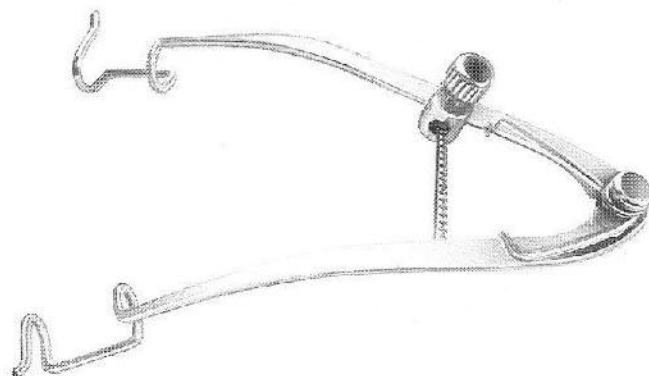
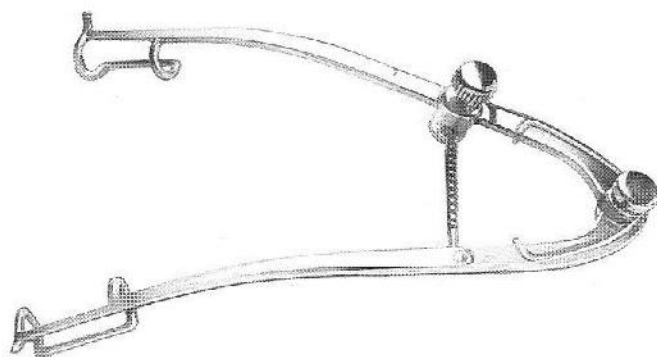

CLARK
Eye Speculum
K-1006

LANCASTER

Eye Speculum

K-1008

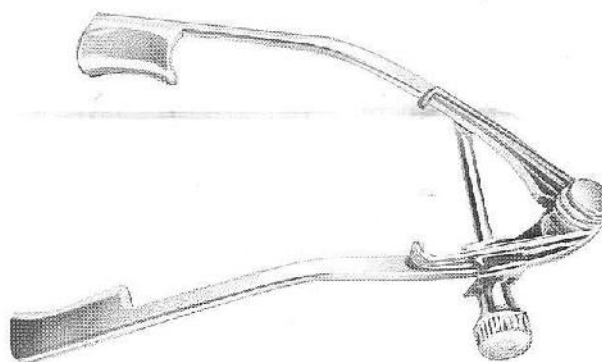

WEISS

Eye Speculum Fenestr Blades

K-1013/1 Child

K-1013/2 Adult

WEISS

Eye Speculum Solid Blades

K-1015/1 Child

K-1015/2 Adult

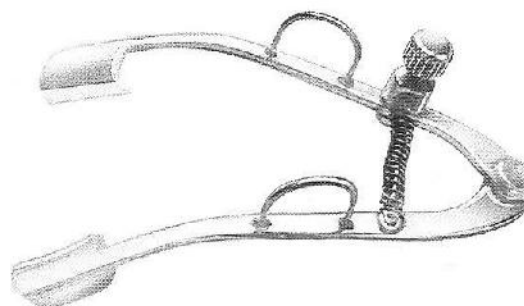

COOK

Eye Speculum

Solid Blades

K-1049/1 Infant

K-1049/2 Child

K-1049/3 Adult

COOK

Eye Speculum

Fenestrated Blades

K-1050/1 Child

K-1050/2 Adult

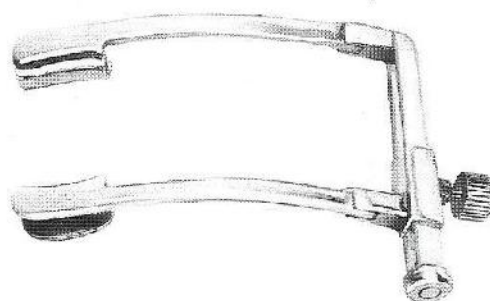

PARK

Eye Speculum

K-1028

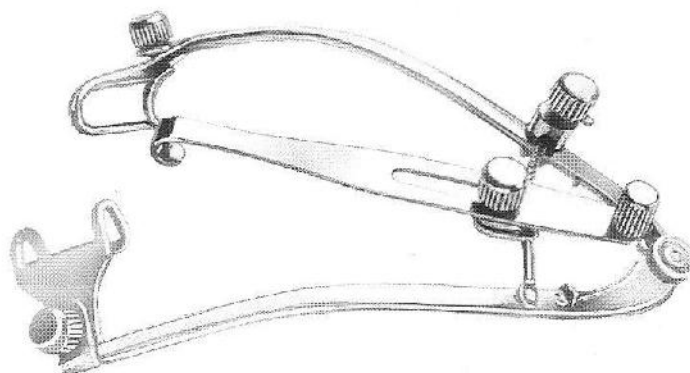

CASTROVIEJO

Eye Speculum

K-1031/1 Small

K-1031/2 Medium

K-1031/3 Large

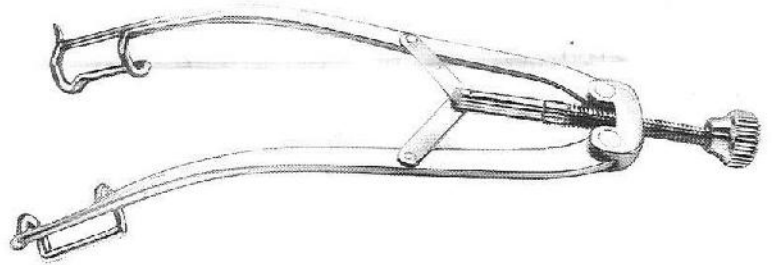

FISHKIND-CASTROVIEJO

Lid Speculum Open Blades

K-1032

SAUER

Eye Speculation Solid Blades

K-1019/1 Infant 4mm Blades

K-1019/2 Child 8mm Blades

K-1019/3 Adult 14mm Blades



BARRAQUER

Wire Speculum

K-1020/00 New born 2mm Blades

K-1020/0 Infant 4mm Blades

K-1020/1 Child 8mm Blades

K-1020/2 Medium 10 mm Blades

K-1020/3 Large 12mm Blades

K-1020/4 Extra Large 14mm Blades

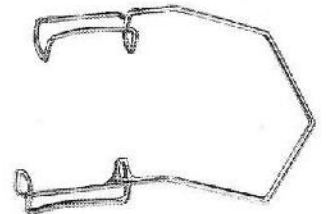

BARRAQUER

Wire Speculum Solid Blades

K-1021/0 Infant 4mm Blades

K-1021/1 Small 8mm Blades

K-1021/2 Medium 10mm Blades

K-1021/3 Large 12mm Blades

K-1021/4 Extra Large 14mm Blades

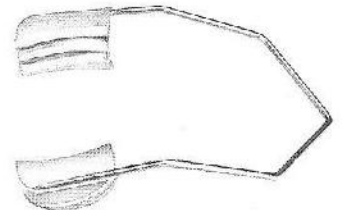

GRANDON-BARRAQUER

Wire Speculum

K-1024/A with Suture Notches

K-1024/B Solid Blades With Suture Holes

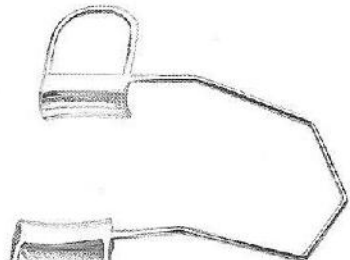
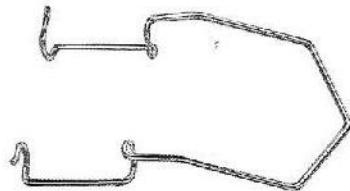
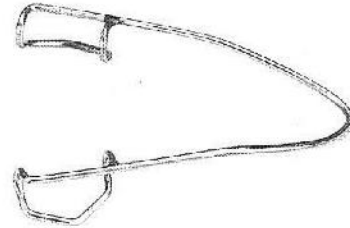
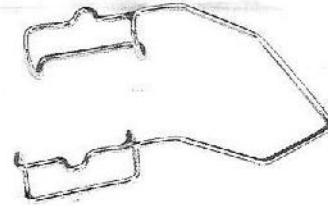

McINTYRE

Wire Speculum V Shaped Blades

K-1025

KRATZ-BARRAQUER

Wire Speculum Open Blades

K-1043/1 Child

K-1043/2 Adult

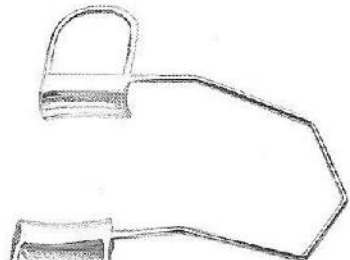
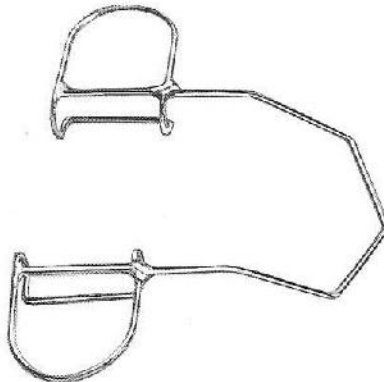

SIMCOE-BARRAQUER

Wire Speculum

K-1045/A Wire Blades

K-1045/B Semi-Solid Blades



speculums

BARRAQUER

Wire Speculum
with reversed spring
for Temporal surgery
K-1020/R

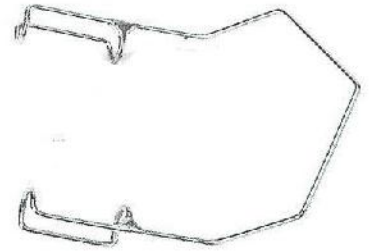

KRATZ- BARRAQUER

Open Wire Speculum
for Temporal Surgery
K-1043/IR child
K-1043/ZR Adult

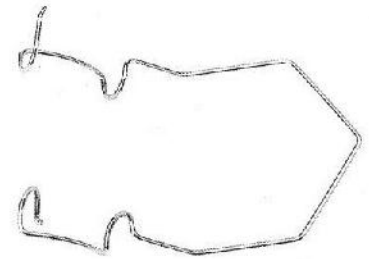

NEVYAS

Wire Speculum
for retaining disposal
drape under eyelids
K-1056

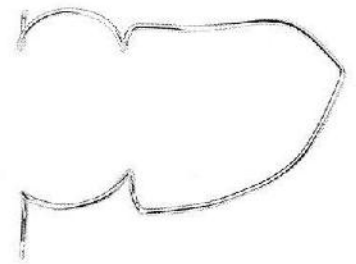

NEVYAS

Eye Speculum
for ALK & RK Surgery
K-1057

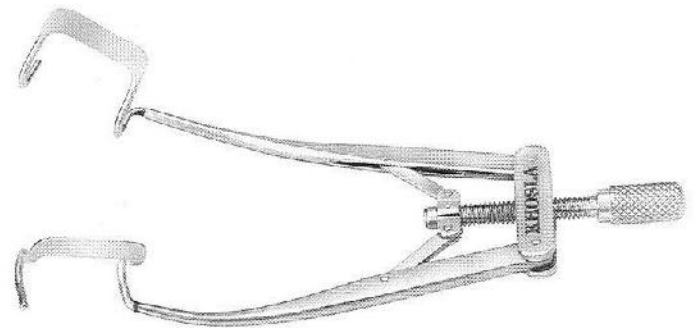

Nasal Speculum
for Temporal Incision
K-1058

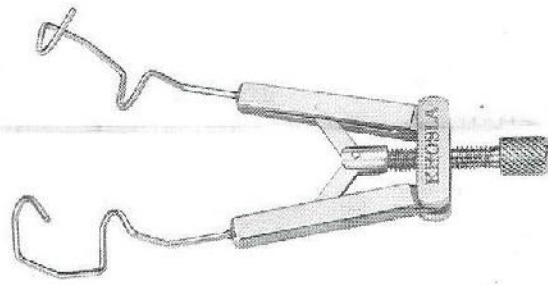

Temporal Speculum
for regular Incision
K-1059

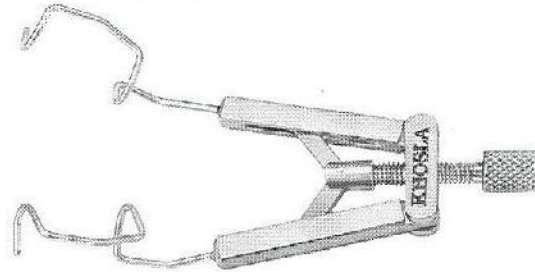

Nasal Solid Blade Speculum
for Temporal Incision
K-1060

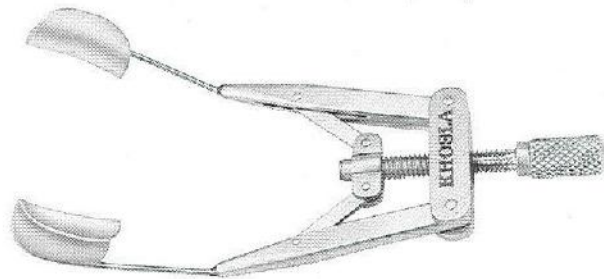

Universal Reversible
lid Speculum
K-1061

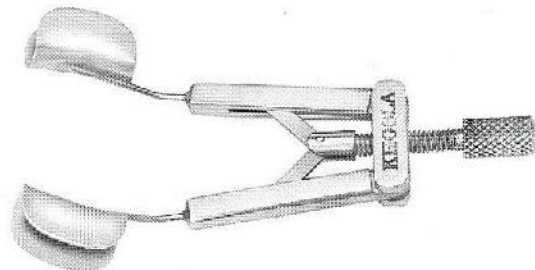

Nasal Speculum
with Aspiration
K-1062

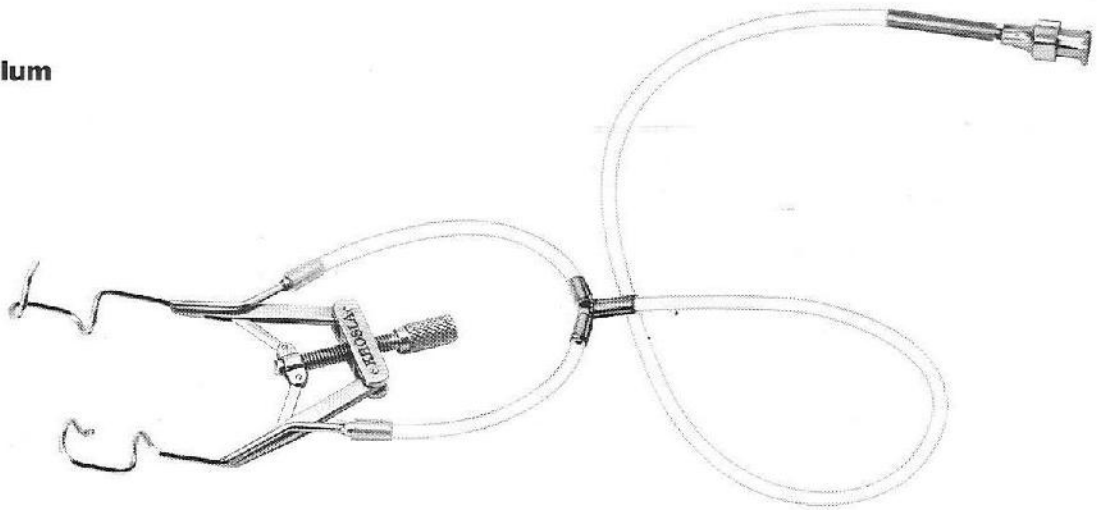

Temporal Speculum
with Aspiration
K-1063



Kratz
Aspiration Speculum
K-1064

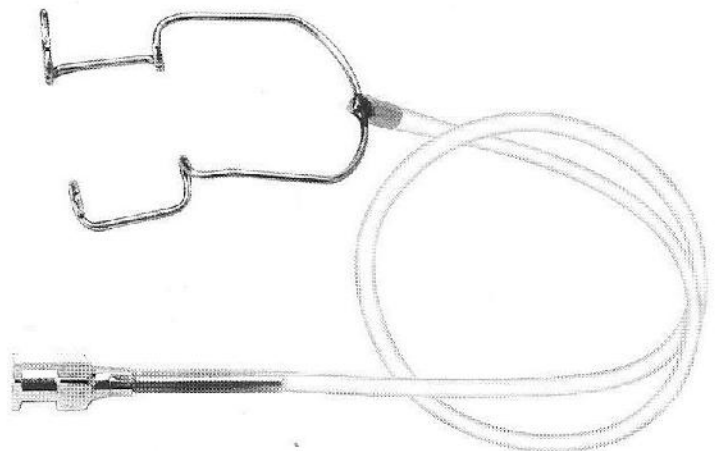

MUELLER
Lacrimal Sac Retractor
K-1037

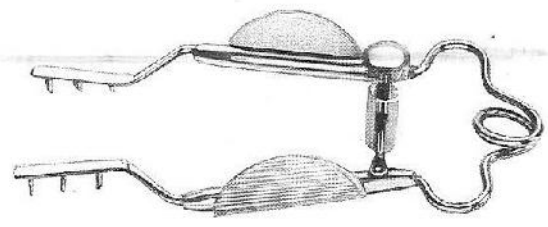

STEVENSON
Lacrimal Sac Retractor
3 x 3 Blunt Prongs.
K-1038

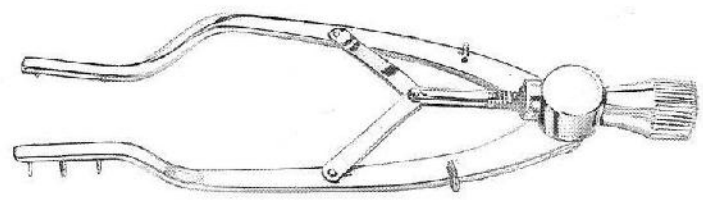

STEVENSON
Lacrimal Sac Retractor
Solid Blades With Serrated Edge
K-1039

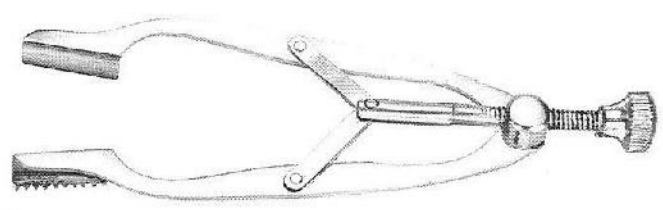



retractors

ROLLET

Lacrimal Sac Retractor

K-1607 Sharp

K-1608 Blunt



AXENFELD

Lacrimal Sac Retractor

3 Prong

K-1613 Sharp

K-1614 Blunt



KNAPP

Lacrimal Sac Retractor

4 Prong

K-1654/1 Sharp

K-1654/2 Blunt



DESMARRES

Lid Retractor

K-1101/0 Infant 7.5mm

K-1101/1 Child 11mm

K-1101/2 Small 13mm

K-1101/3 Medium 15mm

K-1101/4 Large 17mm



JAFFE

Lid Retractor (Pair)

K-1108/1 Small (Pair)

K-1108/2 Large (Pair)



NEWELL

Lid Retractor (Pair)

K-1109

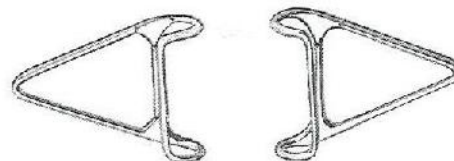

TENNANT

Lid Retractor (Pair)

K-1110

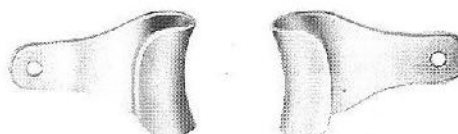



iris retractors

ROSENBAUM-DREWS

Iris Retractor

K-1115 Left and Right

K-1115/L Left

K-1115/R Right



RIZZUTI

Iris Retractor And Lens Expressor

K-1116



ROGER

Iris Retractor

K-1123/S Straight

K-1123/L Left

K-1123/R Right



SPIVEY

Iris Retractor

K-1615



GRAETHER

Collar Button Iris Retractor

K-1631/S Straight

K-1631/A Angled

K-1631/B Angled Left

K-1631/C Angled Right



SCHEPENS

Orbital Retractor

K-1717

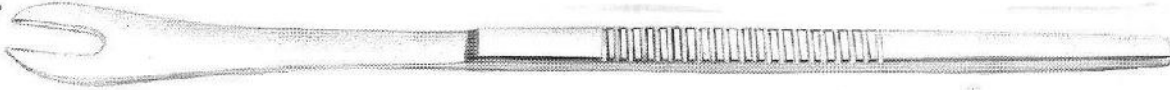

SCHOCKET

Scleral Depressor Double Ended

K-1111



SCHEPENS

Scleral Depressors With Thimble

K-1112/1 Small 8mm

K-1112/2 Medium 10mm

K-1112/3 Large 12mm



FLIERINGA

Scleral Fixation Rings

Set of 8 Sizes (15-22mm)

K-1113

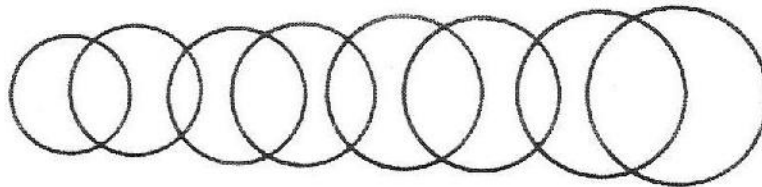

JAEGER

Spatula, All Metal

K-1104



GRAEFE

Cataract Knife

K-1300/1 25mm X 1.5mm

K-1300/2 27mm X 1.7mm

K-1300/3 30mm X 2.0mm

K-1300/4 33mm X 2.3mm

K-1300/5 35mm X 2.5mm



ZIEGLER

Iris Knife

K-1417/1 5mm

K-1417/2 6mm

K-1417/3 7mm

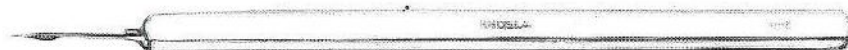

TOOK

Corneal Knife

K-1439

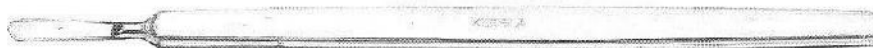

K-1449 Fig. 1,2,3,4.



JOHNSONS

Ptosis Knife

K-1452



NICATI
Foreign Body Spud
K-1515



ELLIS
Foreign Body Spud
K-1520



LA FORCE
Foreign Body Spud
Golf Club Tip
K-1522



FRANCIS
Foreign Body Spud
K-1523



WILLS EYE HOSPITAL
Foreign Body Spud &
Burr For Rust Ring Removal
K-1524





muscle hooks

JAMESON

Muscle Hook

K-1620/1 Small

K-1620/2 Large

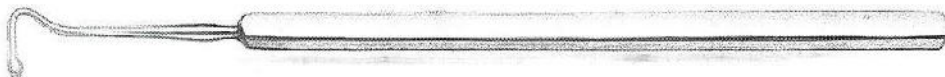

GRAEFE

Muscle Hook

K-1622/1 Small

K-1622/2 Medium

K-1622/3 Large

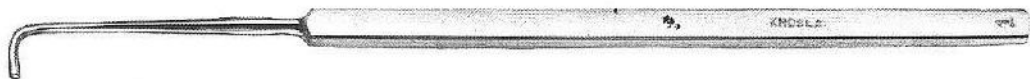

O'CONNOR

Tenotomy Hook

K-1624

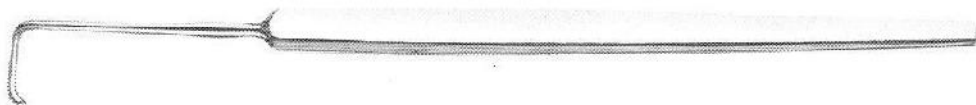

GREEN

Muscle Hook

K-1625



CULLER

Rectus Muscle Hook

K-1626



STEVENS

Tenotomy Hook

K-1627

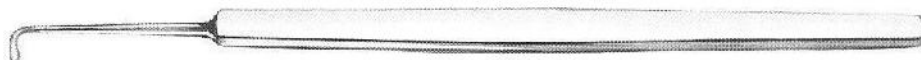

CULLER

Rectus Muscle Hook

Delicate

K-1628



GRAEFE
Iris Hook
K-1600 Sharp
K-1601 Blunt

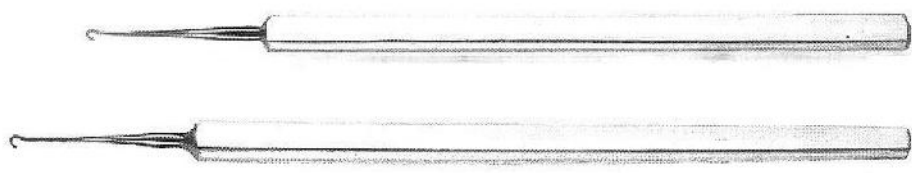

SHEPARD
Iris Hook, Blunt
K-1638

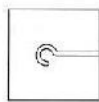

BONN
Micro Iris Hook, Blunt
K-1639



JAFFE-KNOLLE
Iris Hook, Blunt
K-1651/S Straight
K-1651/A Angled





lens manipulators

SINSKEY

Lens Manipulator

K-1632 Straight

K-1633 Angled

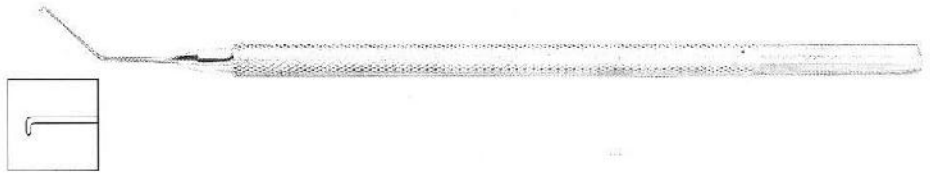

HIRSCHMAN

Lens Spatula

Notched For IOL Manipulation

K-1636

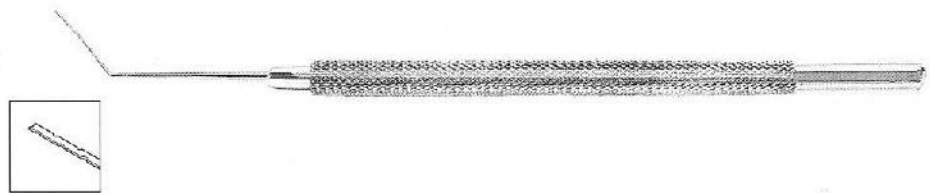

KUGLEN

Iris Hook & Lens Manipulator

Clover Leaf Tip

K-1637/S Straight

K-1637/A Angled



KUGLEN

Iris Hook & Lens Manipulator

Push Pull Model

K-1656/S Straight

K-1656/A Angled



LESTER

Lens Manipulator
K-1640/S Straight
K-1640/A Angled

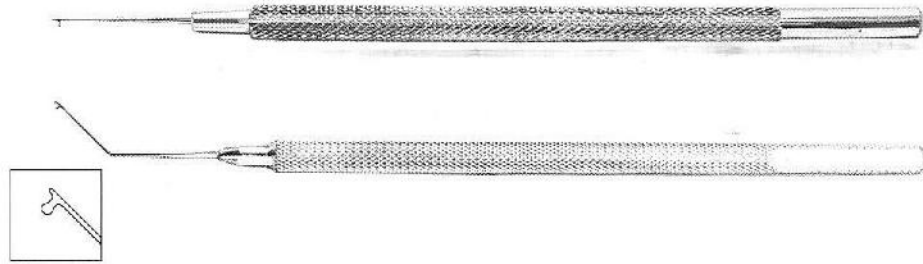

AKER

Lens Pusher
K-1647/S Straight
K-1647/A Angled



FENZL

Lens Insertion Hook & Manipul
K-1648/S Straight
K-1648/A Angled

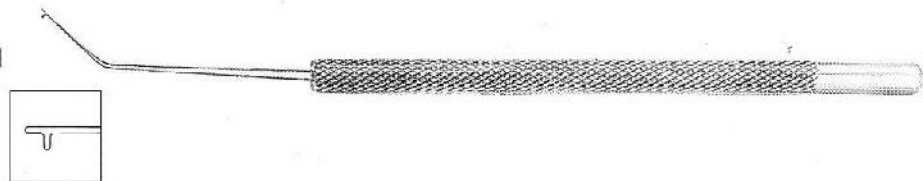

LEWICKY

Lens Manipulator
K-1658



MALTZMAN-FENZL

Lens Manipulator V Shaped Tip
K-1659/S Straight
K-1659/A Angled

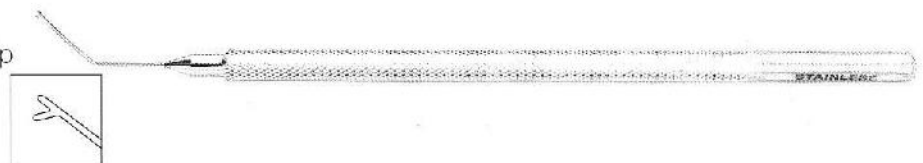



lens manipulators

OSHER

Y Hook Lens Manipulator

K-1660



LESTER

Lens Manipulator

Modified Vaulted Shank

K-1661



HUNKELER

Lens Manipulator Angled

K-1662



MALONEY

Nucleus Rotator

K-1663



DOUBLE HOOK

Nucleus Rotator & Iris Retractor

K-1664



BECHERT

Nucleus Rotator Angled
K-1644/1 Angled 7mm
K-1644/2 Angled 9mm

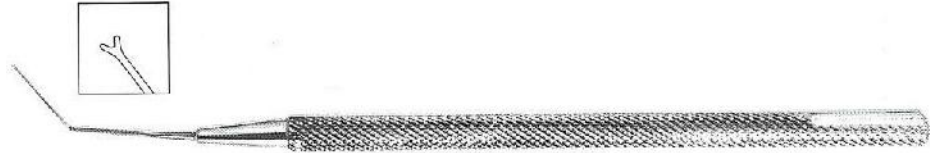

CLAYMAN

Nucleus Rotator
K-1665

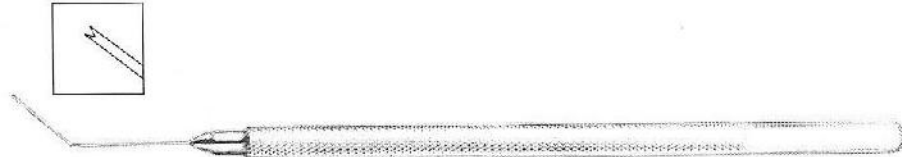

DRYSDALE

Nucleus Rotator
K-1666



PISACANO

Nucleus Rotator
K-1667



TENNANT

Nucleus Rotator Ball Tip
K-1668



ROSEN
Phaco Chopper
K-1739

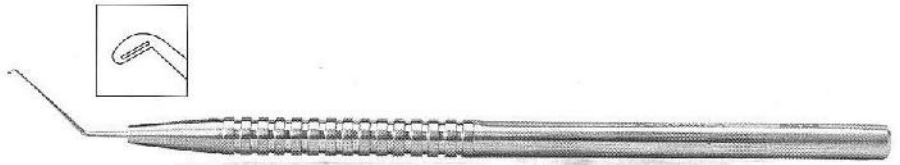

NAGAHARA
Phaco Chopper
K-1756

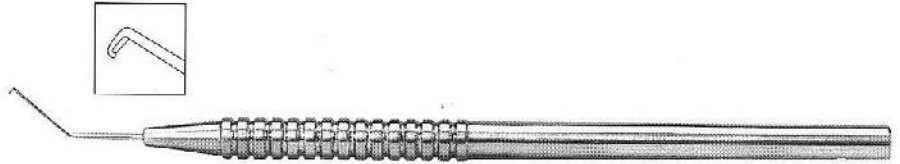

FUKASAKU
Small Pupil
Snapper Hook & Phaco Chopper
K-1757

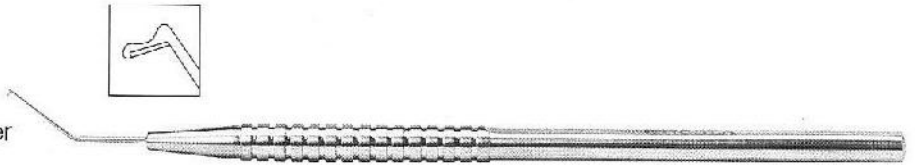

KOCH
Nucleus Divider
Strongly Curved
Spatulated Tip
K-1758

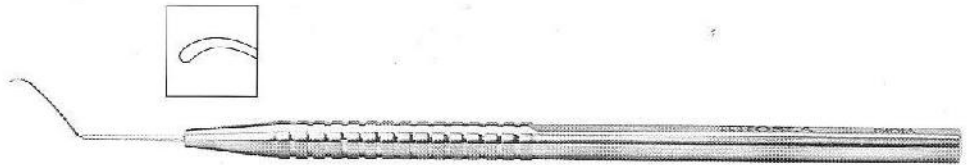

LIEBERMAN
Micro Finger Nucleus Manipul
K-1764

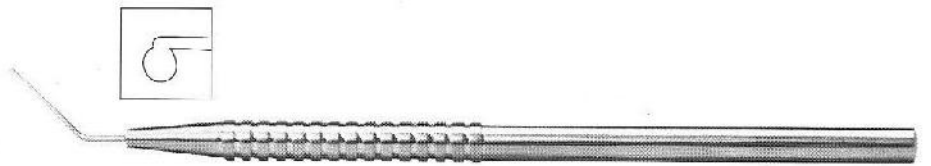

Nucleus Sustainer
for use with Phaco Prechpper
K-1765

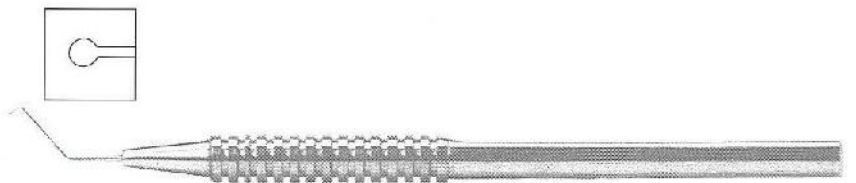

TROTMAN-BARRAQUER

Iris Spatula

K-1444



WECKER

Iris Spatula

K-1700/1 1mm Width Curved

K-1700/2 1mm Width Curved



BARRAQUER

Iris Spatula

K-1703



CASTROVIEJO

Cyclodialysis Spatula

K-1704/1 10mm

K-1704/2 15mm



ELSCHNIG

Cyclodialysis Spatula

K-1706





spatulas

CASTROVIEJO

Cyclodialysis Spatula Double End
10mm & 15mm .5 Width

K-1722



CASTROVIEJO

Cyclodialysis Spatula Double End
Semi-Sharp .5 Width

K-1722/A



DASTOOR

Pupil & Iris Repositor

K-1723

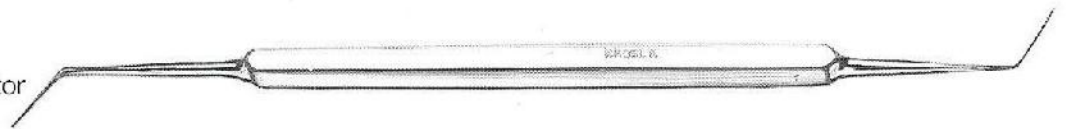

GREEN

Spatula Double End

K-1724/1 Long Handle

K-1724/2 Short Handle



KREEN

Spatula & Hook

K-1728

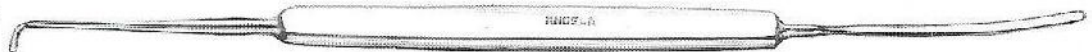

TROUTMSAN
Lens Spatula
K-1446



TROUTMSAN
Lens Loop
K1445



ARLT
Lens Loop Serrated
K-1707



SNELLEN
Lens Loop
K-1708

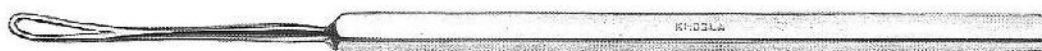

NEW ORLEANS
Lens Loop
K-1709



WEBER
Lens Loop
K-1714/1 Small
K-1714/2 Large



PATON
Spatula & Spoon
K-1732

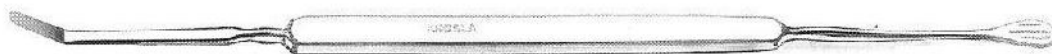

LEWIS
Lens Loop
K-1733/1 Small
K-1733/2 Large

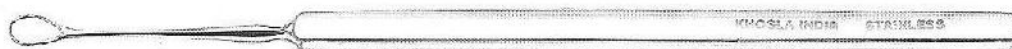

WILDER
Lens Loop Serrated
K-1735



KIRBY
Lens Loop & Muscle
K-1736

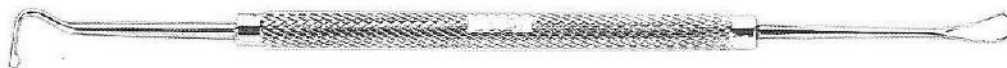

SIMCOE
Lens Nucleus Loop Serrated
Double End
K-1737

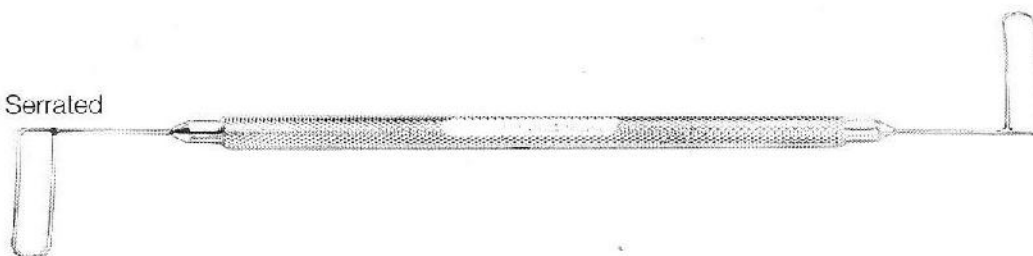

GILLS- WELSH

Lens Loop With Ultra Thin Blade

K-1634

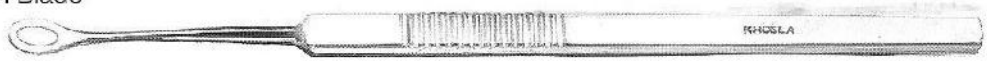

GILLS - WELSH

Lens Loop With Olive Tip Probe

Double End

K-1635

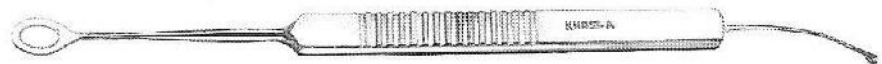

SMITH

Lens Expressor

K-1621

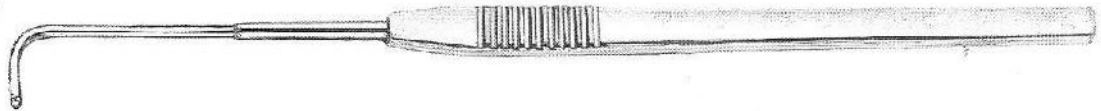

SMITH

Lens Expressor & Loop

Double End

K-1621/A

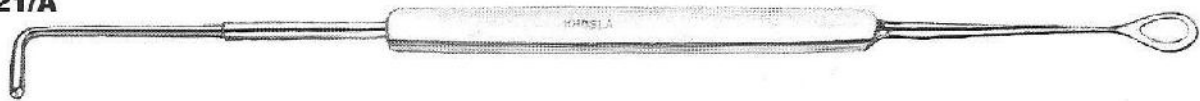

Cystotome & Loop

K-1455





nucleus splitters

KANSAS

Lens Loop Serrated 3mm Wide
for small incision nucleus
fragment removal

K-1740



KANSAS

Nucleus Trisector for manual small
incision surgery

K-1741



KANSAS

Nucleus Bisector for
Manual small incision surgery

K-1742



KANSAS

Nucleus Vectis Solid
used as cutting block
with Kansas trisector & bisector
for nucleus fragmentation

K-1743



WELLS

Enucleation Spoon

K-1716



PAGENSTECHER
Eye Spoon
K-1802



BUNGE
Evisceration Spoon
K-1808/1 8.0mm
K-1808/2 9.0mm
K-1808/3 10.0mm
K-1808/4 11.0mm
K-1808/5 12.0mm



HEBRA
Chalazion Curette, Sharp
K-1803/1 2.5mm
K-1803/2 3.5mm
K-1803/3 4.5mm



MEYHOEFER
Chalazion Curette, Sharp 1mm
K-1804

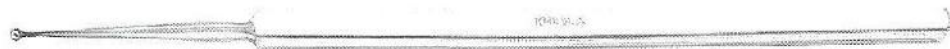

MEYHOEFER
Chalazion Curette, Sharp
K-1805/0 1.50mm
K-1805/1 1.75mm
K-1805/2 2.25mm
K-1805/3 2.50mm
K-1805/4 3.50mm



AXENFELD

Chalazion curette, Sharp Double End
K-1810



NIGHTINGALE

Capsule Polishing Curette 1.75mm
K-1820



GILLS

Capsule Polishing Curette 1.75mm
K-1822



ANIS

Capsule Scrubber
K-1823



WILLS HOSPITAL

Cautery, Delicate Copper Ball
K-1815



WILLS HOSPITAL

Cautery, Delicate Copper Tip
K-1816

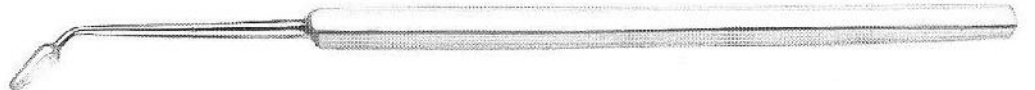

KHOSLA

Hand Cautery With 2 Burners &
Extension Tube For Extra Cell,
Complete In A Box, Battery Operated.

K-1752

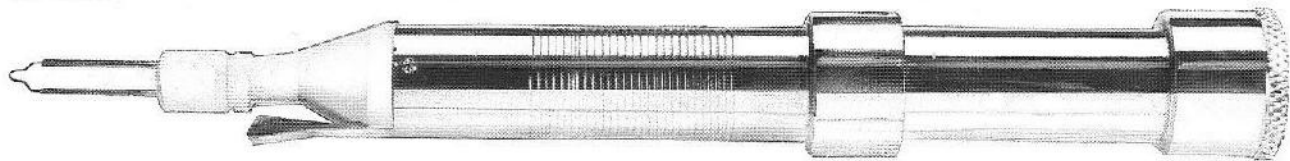

ALGERBRUSH

Corneal Rust Ring Remover
Battery Operated Complete

K-1755

K-1755/A Extra Burr 0.5mm

K-1755/B Extra Burr 1.0mm

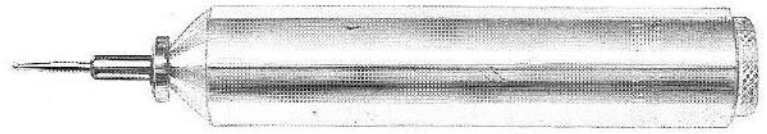
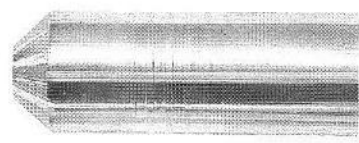

Flexible Rule, Stainless Steel

K-2000



calipers

CASTROVIEJO

Caliper 15mm

K-2002/S Straight

K-2002/C Curved

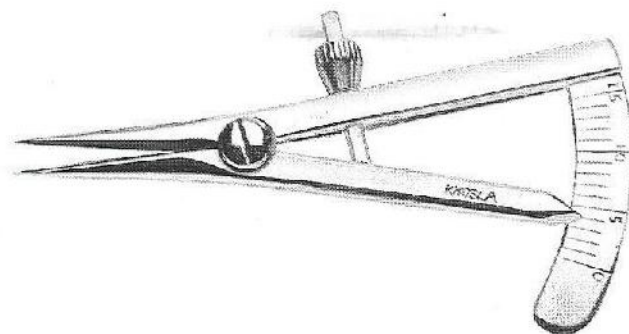

CASTROVIEJO

Caliper 20mm

K-2003/S Straight

K-2003/C Curved

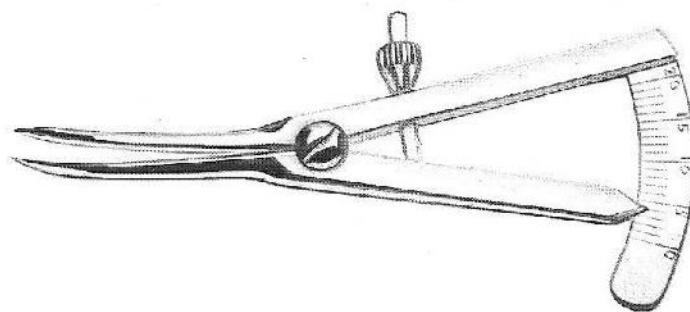

BOWMAN

Lacrima Probe, Cylindrical Set Of 4 Sizes
K-2300

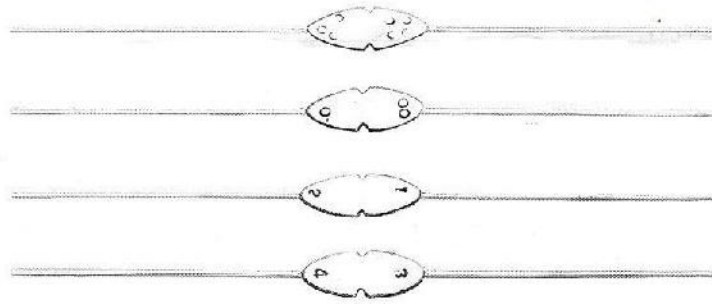

ZIEGLER

Probe For Lacrima Canal
K-2304



ROLF

Probe For Lacrima Sac
K-2305



PIGTAIL

Probe

K-2306/A With Suture Holes

K-2306/B Without Suture Holes

K-2306/C Curly Type With Suture Holes



HARMS

Trabeculotomy Probe

K-2315/L Left

K-2315/R Right

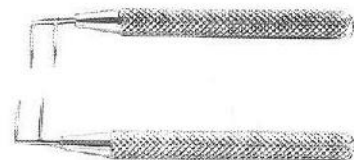



Lacrimal instruments

WILDER

Lacrimal Dilator

K-2307/1 Fine Taper

K-2307/2 Medium Taper

K-2307/3 Heavy Taper

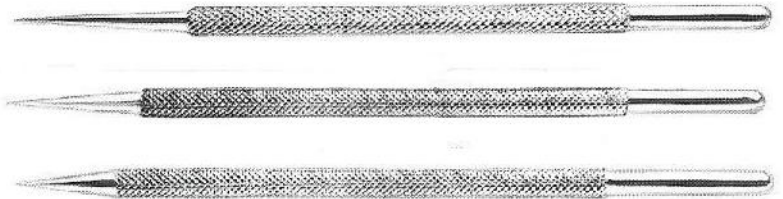

Infant lacrimal Dilator Very Fine Blunt Tip

K-2308



CASTROVIEJO

Lacrimal Dilator Double End Fine & Medium Taper

K2309

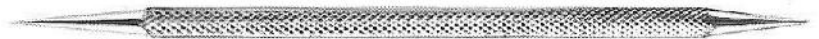

DASTOOR

Lacrimal Sac Dissector Double End

K-2310



LANG

Lacrimal Sac Dissector Double End

K-2311



GRAEFE

Scarifier For Lacrimal Sac

K2312



DESMARRES

Scarifier For Lacrimal Sac

K-2313



WEST

Bone Chisel For Lacrimal Sac Straight

K-2404



WEST

Bone Chisel For Lacrimal Sac Straight

K-2405



FREER

Bone Chisel For Lacrimal Sac Curved

K-2408



JOSEPH

Periosteal Elevator

K2406

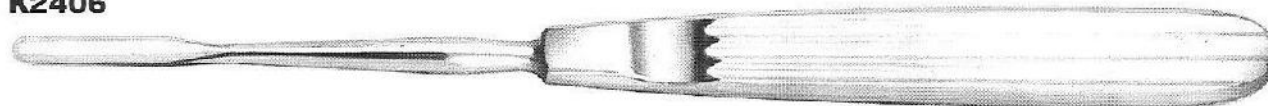

FREER

Periosteal Elevator Double End Sharp & Blunt

K-2407



CRAWFORD
Lacrimal Instrument Set
K-2409/1



CRAWFORD
Retrieving Hook
K-2409/2



ROLLET
Rugine For Lacrimal Sac
K-2411



HAMMER
For Dcr
K2412

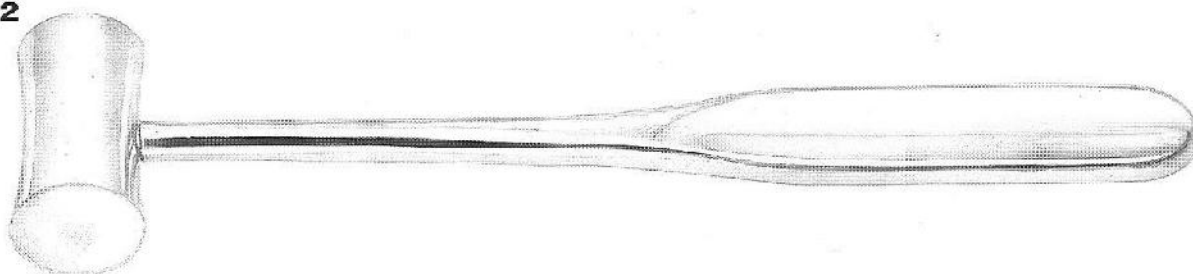

NASAL SPECULUM
K-1055/1 Infant
K-1055/2 Child
K-1055/3 Adult

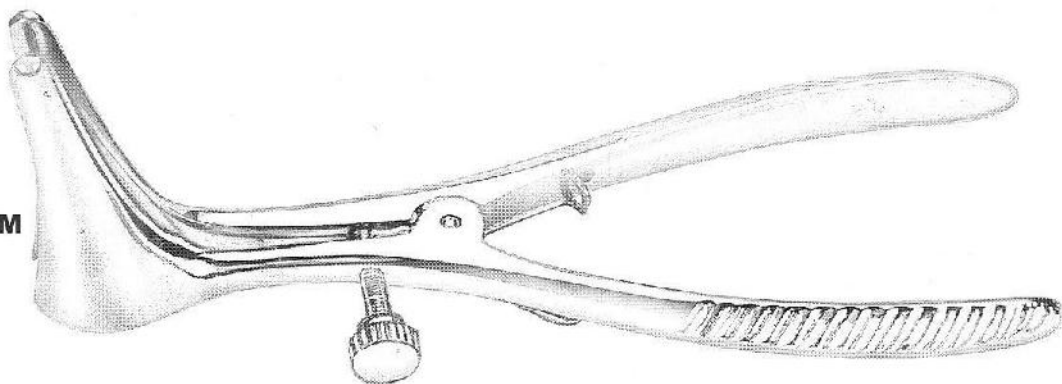

ELLIOT

Scleral Trephine Handle

K-1900

K-1900/A 1 mm Blade

K-1900/B 1.5 mm Blade

K-1900/C 2.0 mm Blade

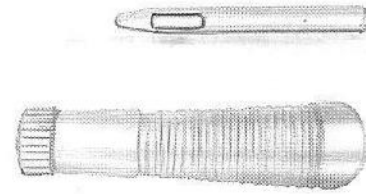

CASTROVIEJO

Corneal Trephine

K-1901

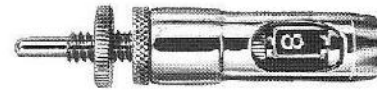

CASTROVIEJO

Corneal Trephine Blade, Long
available in .25 mm increments
from 6.0 mm to 11 mm dia.

K-1903

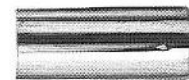

CASTROVIEJO

Corneal Trephine Blade, Short
available in .25 mm increments
from 6.0 mm to 11 mm dia.

K-1902





punches

LUNTZ-DODICK

Trabeculectomy Punch
Rotatable Cutting

K-2415S/A 0.5 mm Tip

K-2415S/B 1.0 mm Tip

K-2415S/C 1.5 mm Tip

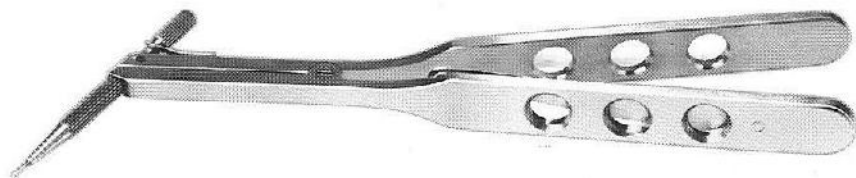

KELLEY

Decemets
Membrane Punch

K-2413 /1.0 mm Bite

K-2413 /A 0.75 mm Bite

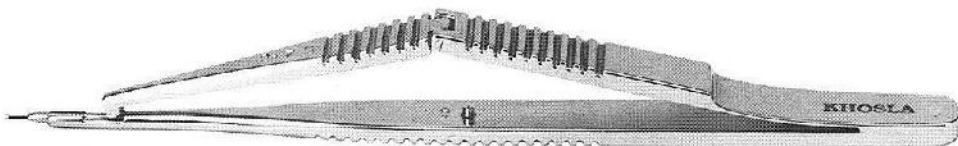

GASS

Corneoscleral Punch
1.0 mm dia
Rotatable Tip

K-2415

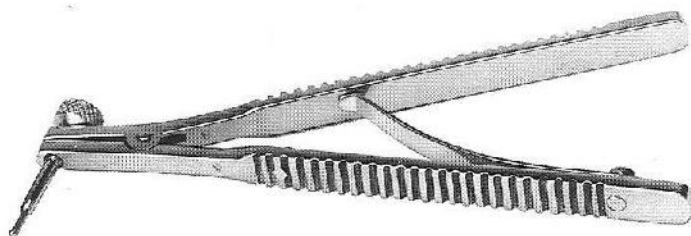

CITELLI
Bone Rongeur
K-2400

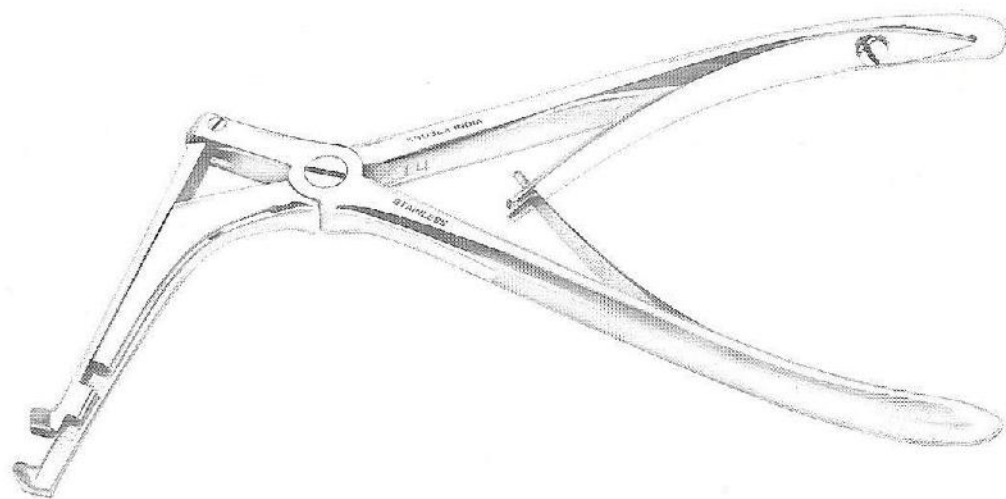

BEYER
Bone Rongeur
K-2401

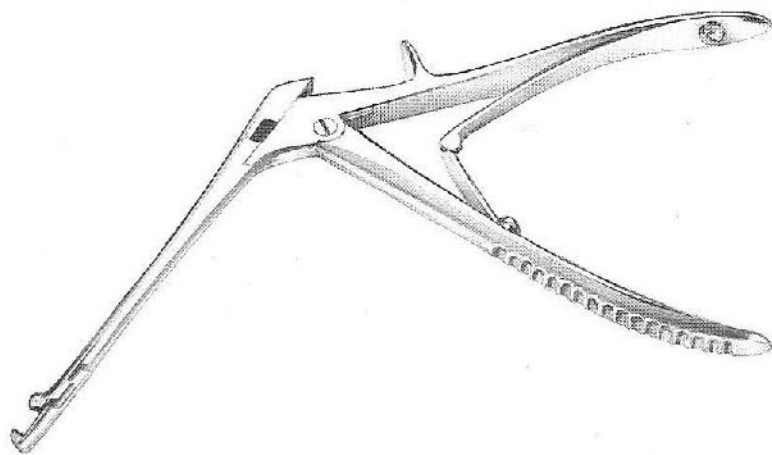



rongeurs

KERRISON

Bone Rongeur

K-2402/1 Small

K-2402/2 Medium

K-2402/3 Large

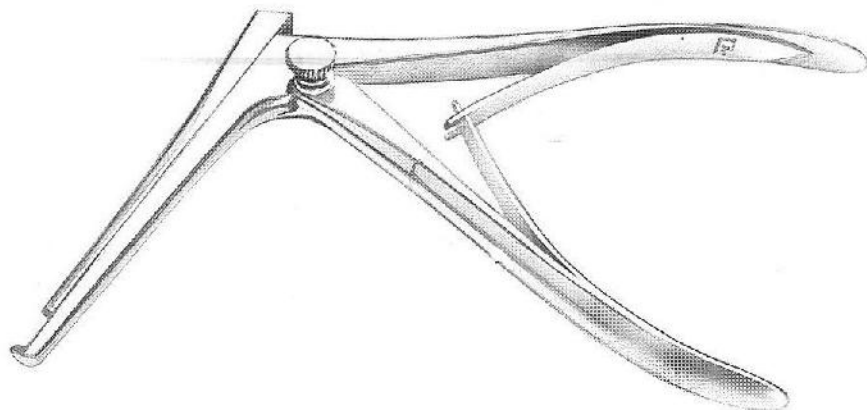

ADLER

Bone Rongeur

K2403

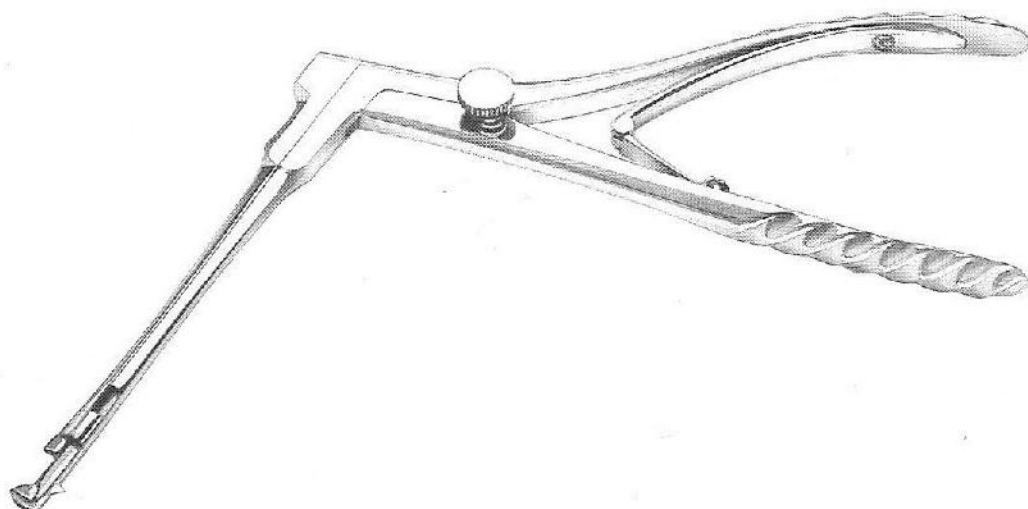

HOLTH

Corneoscleral Punch

K-2410/1 1mm Jaw

K-2410/2 1.5mm Jaw

K-2410/3 2mm Jaw

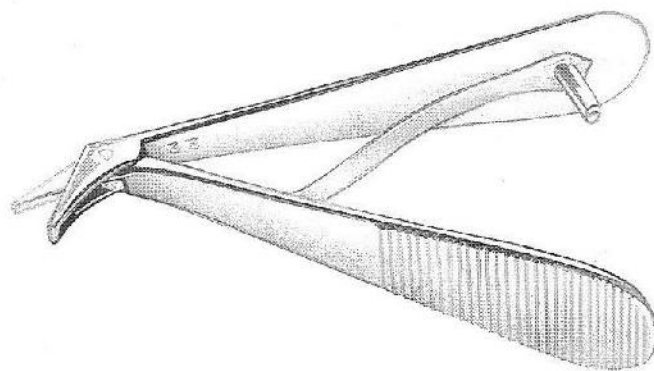

HARTMANN

Mosquito Forceps 3.25"

K-2100/S Straight

K-2100/C Curved

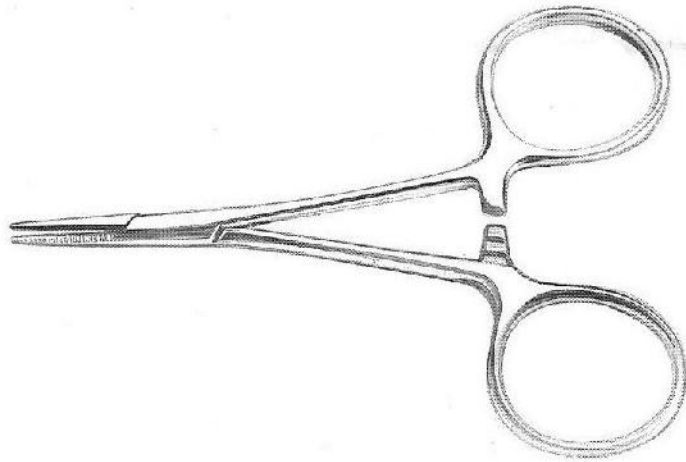

HALSTED

Mosquito Forceps 5.50"

K-2101/S Straight

K-2101/C Curved

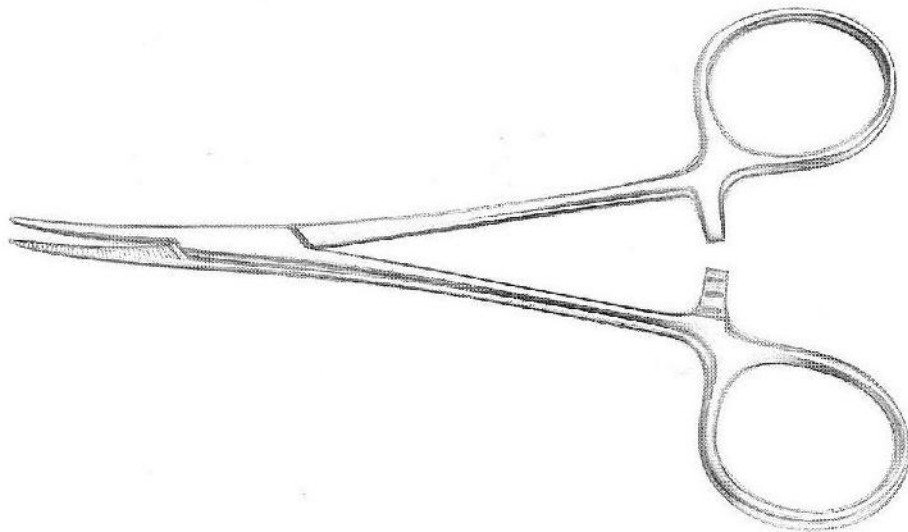

SERREFINE

1.5"

K-2103 Straight

K-2103 Curved





forceps

BACKHAUS

Towel Clamp

K-2105/1 3.50"

K-2105/2 5.25"

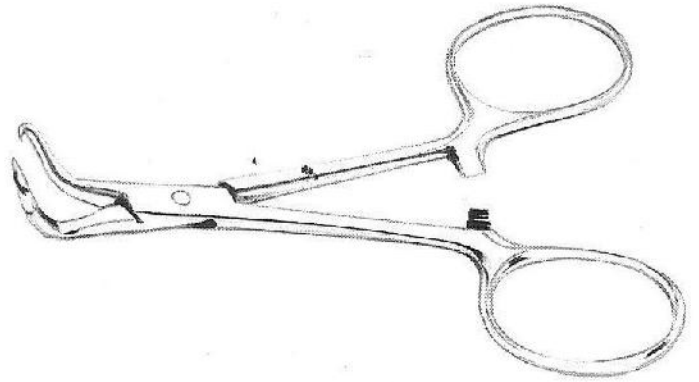

JONES

Towel Clamps

K2106

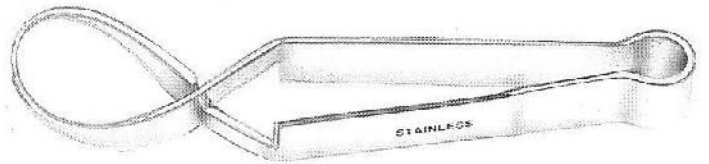

Eye Dressing Forceps

Serrated, Straight

K-2500



Eye Dressing Forceps

Serrated, Half Curved

K-2501



Eye Dressing Forceps

Serrated, Full Curved

K-2502

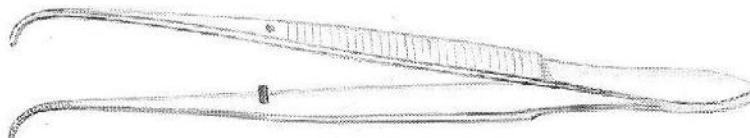

IRIS FORCEPS

1 X 2 Teeth, Straight

K-2503



IRIS FORCEPS

1 X 2 Teeth, Half Curved

K-2504

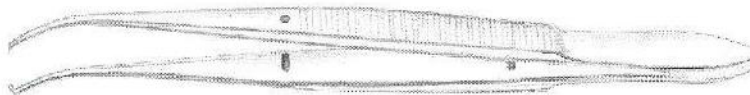



forceps

IRIS FORCEPS

1 X 2 Teeth, Full Curved
K-2505

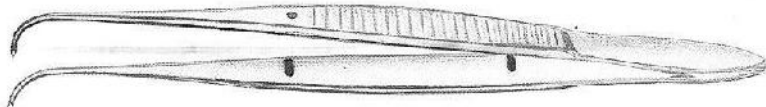

BISHOP-HARMON

Iris Forceps 1 X 2 Teeth, Extra Delicate
K-2517/A 0.3mm Teeth
K-2517/B 0.5mm Teeth
K-2518 Serrated

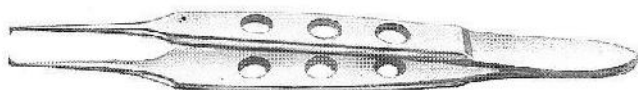

HEES

Iris Forceps Swiss Model 1 X 2 Teeth
Very Delicate
K-2524

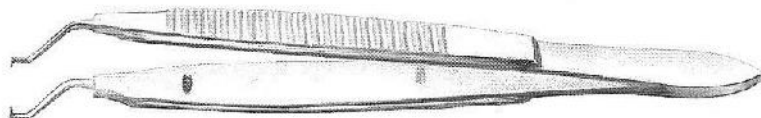

UTILITY

Forceps 4" Serrated, Straight
K-2530

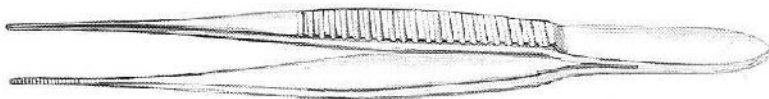

UTILITY

Forceps 4" 1 X 2 Teeth, Straight
K-2531

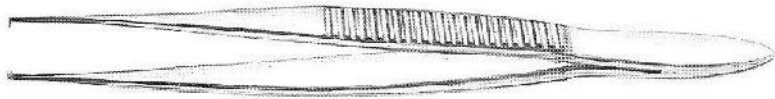

McCULLOUGH
Utility Forceps Serrated
K-2532

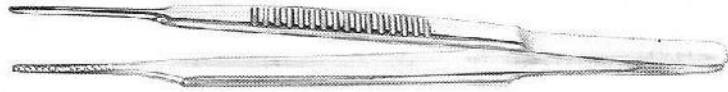

McCULLOUGH
Utility Forceps 1 x 2 Teeth, Serrated
K-2533



WILLS HOSPITAL
Utility Forceps Serrated
K-2534

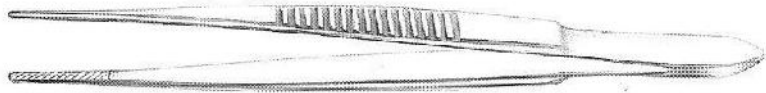

BONACCOLTO
Utility Forceps Delicat Model
K-2535

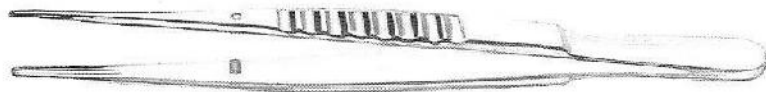

BONACCOLTO
Utility Forceps Heavy Model
K-2536



GRAEFE

Fixation Forceps

K-2538 Without Catch



WALDAU

Fixation Forceps

K-2540



SCHMIDT-RIMPLER

Fixation Forceps

K-2541



JESS

Fixation Forceps

K-2542



BARRAQUER

Fixation Forceps

K-2543

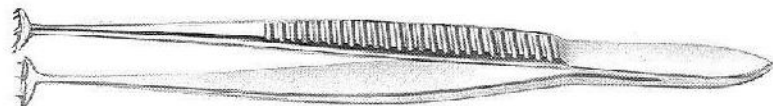

TROUTMAN-LLOBERA

Fixation & Flieringa Ring Holding Forceps

K-2544



GREEN

Fixation Forceps

K-2545/1 5mm Wide

K-2545/2 10mm Wide



ELSCHNIG

Fixation Forceps

K-2546

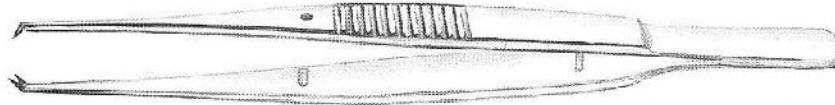

KUHNT

Fixation Forceps

K-2547



Fixation Forceps 4.50"

1 x 2 Teeth

K-2549



Fixation Forceps 4.50"

1 x 2 Teeth

K-2550



Fixation Forceps 4.25"

2 x 3 Teeth

K-2551



LESTER

Fixation Forceps

K-2552/1 1 x 2 Teeth

K-2552/2 2 x 3 Teeth

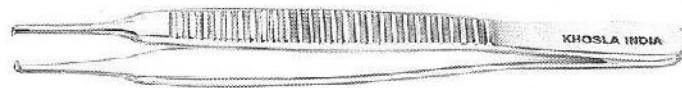



forceps

DASTOOR

Superior Rectus Forceps

K-2554

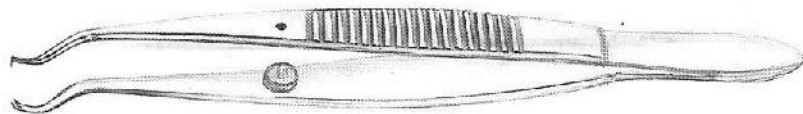

TROUTMAN

Superior Rectus Forceps

K-2555



DASTOOR

Conjunctival-Flap Forceps

K-2560

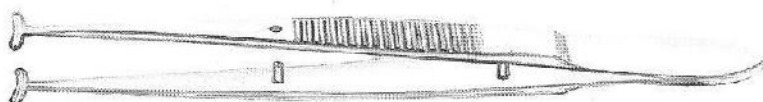

SAUER

Fixation Forceps

K-2611

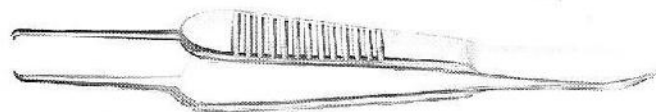

MANHATTAN

Eye & Ear Fixation Forceps

1 x 2 Teeth With Platform

K-2612



BARRAQUER

Colibri Forceps 0.12mm Teeth
K-2600 Without Platform
K-2601 With Tying Platform



HARMS

Colibri Forceps 0.12mm Teeth
Delicate With Tying Platform
K-2648



CASTROVIEJO

Colibri Forceps 0.12mm Teeth
K-2649

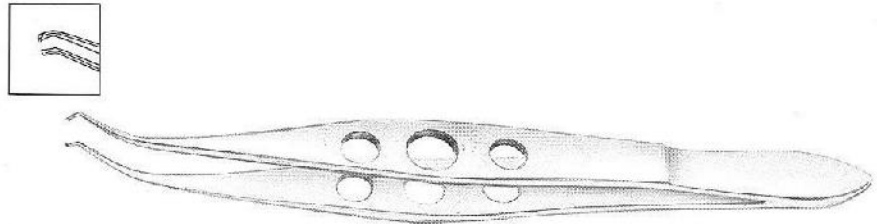

POLACK

Double Corneal Forceps
1mm Spread 0.12mm Teeth At Each tip
K-2652

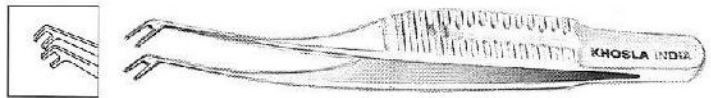

COHAN

Colibri Forceps
0.3mm Teeth With Tying Platform
K-2660



PIERSE

Corneal Colibri Forceps
1 x 1 Pierse Teeth, Delicate
K-2656/1 0.1mm Teeth
K-2656/2 0.3mm Teeth

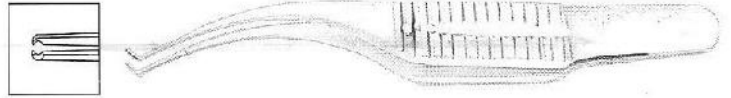

PIERSE

Corneal Forceps
1 x 1 Pierse Teeth, Delicate, Straight
K-2657/1 0.1mm Teeth
K-2657/2 0.3mm Teeth

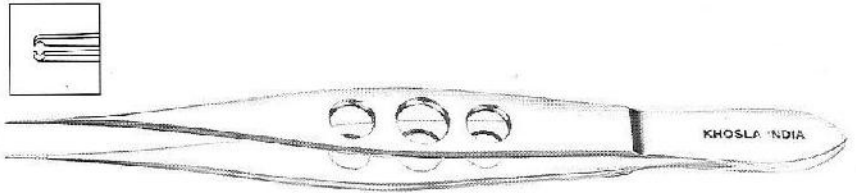

MOORFIELD
Suture Forceps
K-2613

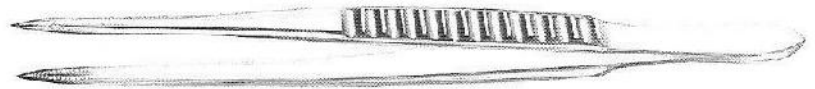

GIRARD

Corneal Scleral Forceps
With Teeth & Platform
K-2566/1 0.3mm Teeth
K-2566/2 0.12mm Teeth

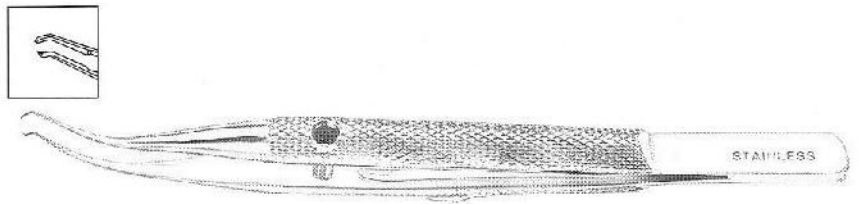

CASTROVIEJO

Suture Forceps
1 x 2 Angled Teeth

- K-2563/A** 0.3mm Teeth
- K-2563/B** 0.5mm Teeth
- K-2564** 0.12mm Teeth

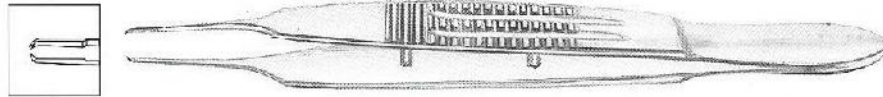

CASTROVIEJO

Suture Forceps

- K-2562/A** 0.12mm Teeth
- K-2562/B** 0.3mm Teeth
- K-2562/C** Smooth Jaws



ST.MARTIN

Suture Forceps 1 x 2 Teeth
K-2608



CASTROVIEJO

Suture Forceps 1 x 2 Teeth

- K-2603** 0.9mm Teeth
- K-2604** 0.5mm Teeth
- K-2605** 0.2mm Teeth

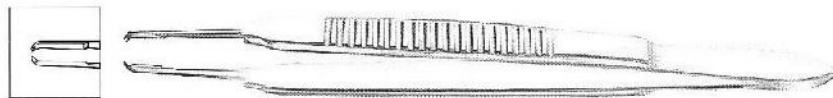

BONN

Forceps 1 x 2 0.12mm Teeth
With Tying Platform Very Delicate

K-2523





forceps

JEWELERS

Forceps

K-2616/1



JEWELERS

Forceps

K-2616/3



JEWELERS

Forceps

K-2616/3c



JEWELERS

Forceps

K-2616/4

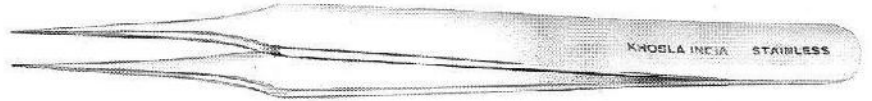

JEWELERS

Forceps

K-2616/5

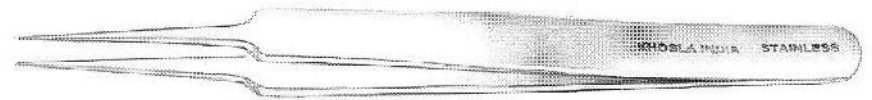

JEWELERS

Forceps

K-2616/5A



JEWELERS

Forceps

K-2616/7

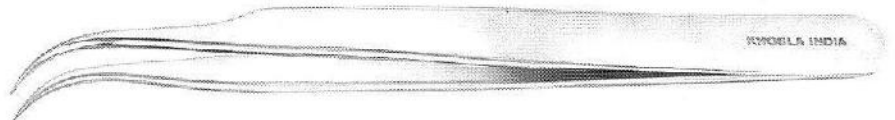

LIMS

Forceps 1 x 2 Teeth Very Delicate
K-2615

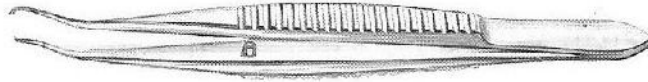

MCPHERSON

Corneal Forceps 1 x 2 Teeth
K-2617 Straight
K-2619 Angled

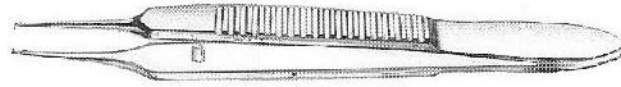

MCPHERSON

Tying Forceps, Smooth Jaws
K-2618 Straight
K-2620 Angled

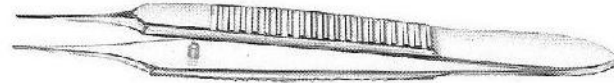

KELMAN-MCPHERSON

Forceps, 8mm Angled Jaw
K-2625 1 x 2 Teeth
K-2626 Smooth

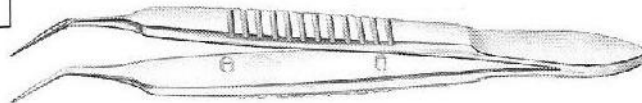
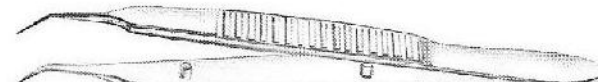

BECHERT- MCPHERSON

Forceps, 11mm Angled
 Smooth Jaws, Delicate
K-2662





forceps

TYING

FORCEPS Without Teeth
K-2602

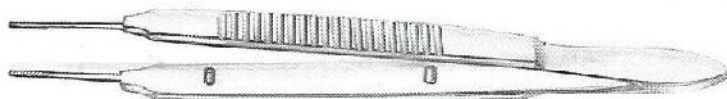

HARMS-JAFFE

Tying Forceps
K-2642/S Straight
K-2642/C Curved



SINSKEY

Tying Forceps
K-2644/s Straight
K-2644/C Curved

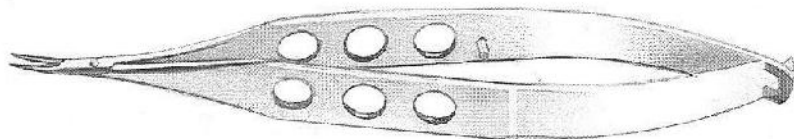

TENNANT

Tying Forceps
K-2646/S Straight
K-2646 C Curved



O'GAWA

Tying Forceps
K-2668/S Straight
K-2668/C Curved

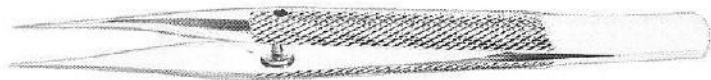

BLAYDES

IOL Insertion Forceps
K-2627

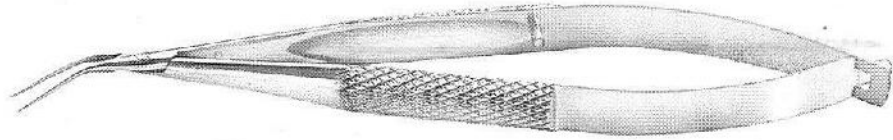

CLAYMAN

Lens Holding Forceps
K-2634

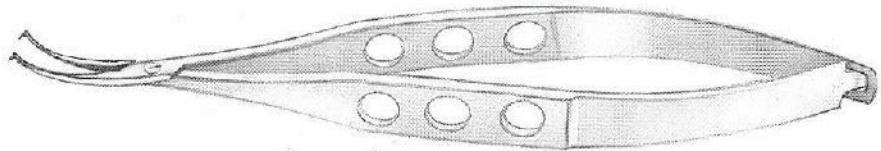

SHEPARD

IOL Forceps, Oval Tip
K-2640 Without Lock
K-2641 With Lock

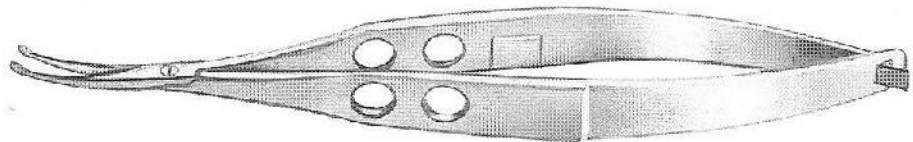

BECHERT

Lens Holding Forceps
Smooth Jaws Gently Curve
K-2676

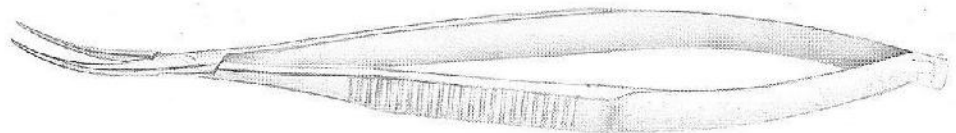



forceps

FAULKNER

Lens Holding Forceps

K-2680

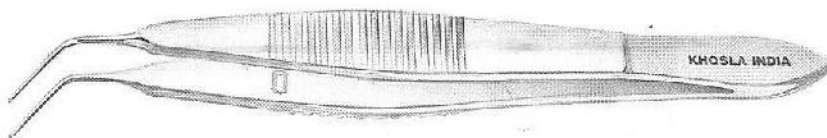

FAULKNER

Lens Holding Forceps

K-2681



BONACCOLTA

Capsules Fragment Forceps

K-2630 Without Catch

K-2631 With Catch

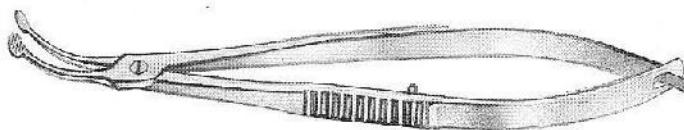

FEASTER

Lens Holding Forceps

Squeeze Handle With Curved Shank

K-2682

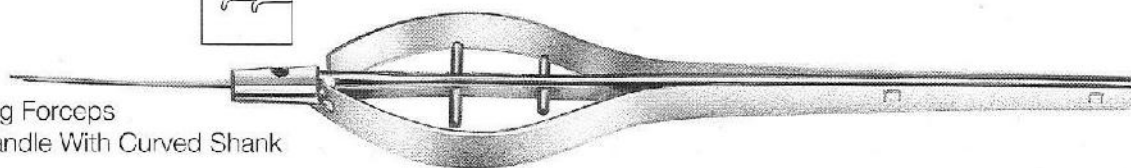

KRAFF

Capsule Tag Forceps 11mm Jaw, Inside Jaw
Surface Recessed To Prevent Iris Pick Up

K-2684

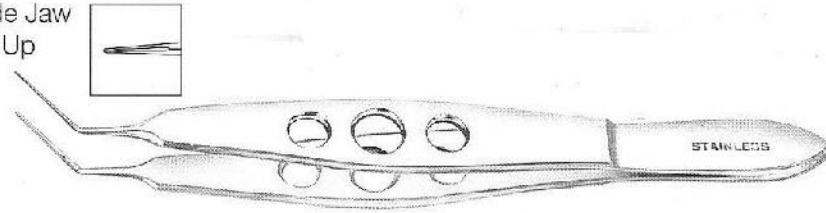

BARRAQUER

Cilia Forceps

K-2703



BEER

Cilia Forceps

K-2704



ZIEGLER

Cilia Forceps

K-2705



ARRUGA
Capsular Forceps
K-2804



ARRUGA
Capsular Forceps New
K-2805



KANSAS
Nucleus Fragment Removing Forceps
K-2810

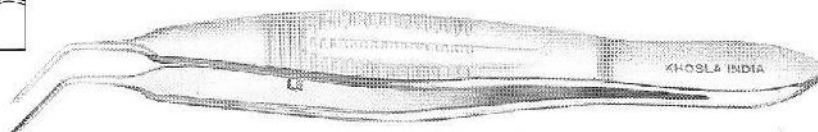

SHAAF
foreign Body Forceps
K-2817

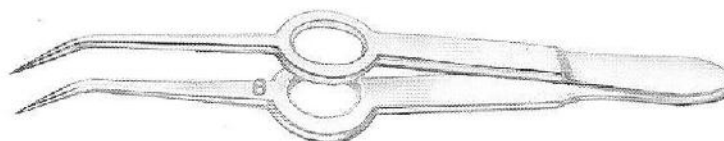

UTRATA

Capsulorhexis Forceps, Cystotome tips,
11mm Long thin Jaws Flat hande

K-2826

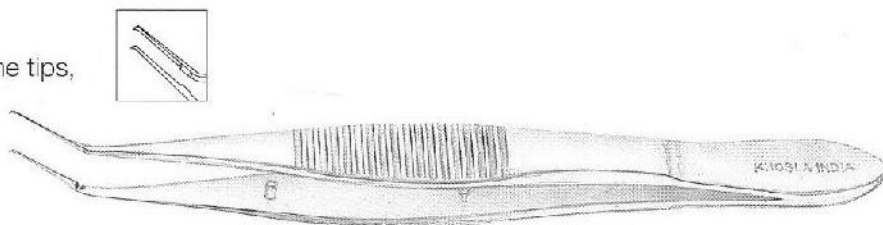

UTRATA

Capsulorhexis Forceps, Cystotome tips,
11mm Long thin Jaws Round hande

K-2827

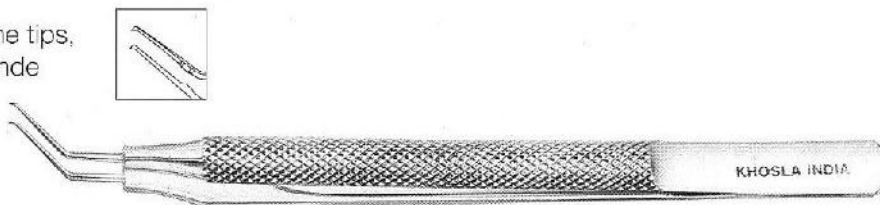

MASKET

Capsulorhexis Forceps, Cystotome Tips,
11mm Long Curved Jaws

K-2828

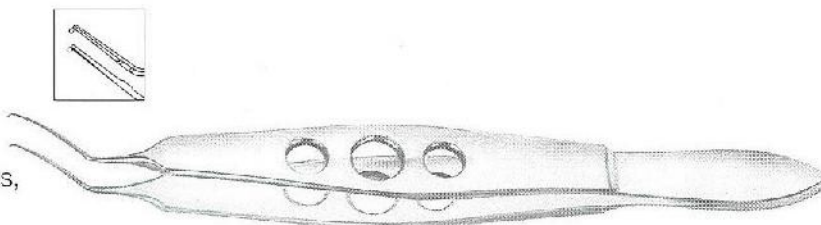

UTRATA

Capsulorhexis Forceps,
Cystotome Tips
11 mm Long Curved Jaws,
Round Handle

K-2834

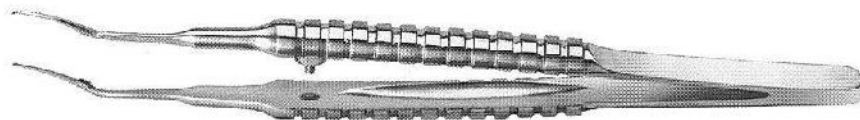

UTRATA

Capsulorhexis Forceps,
Cystotome Tips
11 mm Long Curved Jaws,
Needle Holder Handle

K-2835

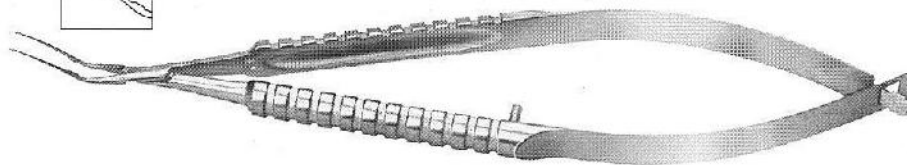

LIVERNOIS

IOL Holding & Folding Forceps
for Silicone Lenses

K-2829

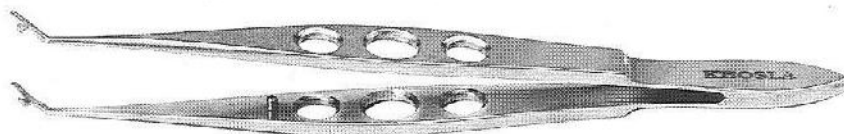

LIVERNOIS

IOL Holding Forceps
Smooth Round Highly Polished Jaws
to avoid damage to the lens

K-2830

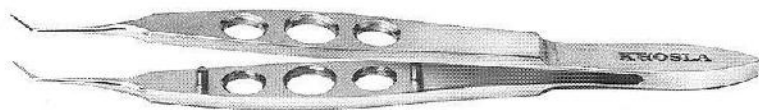

IOL Inserting Forceps
for Acrylic and Silicone Lenses

K-2831 without Lock

K-2832 with Lock

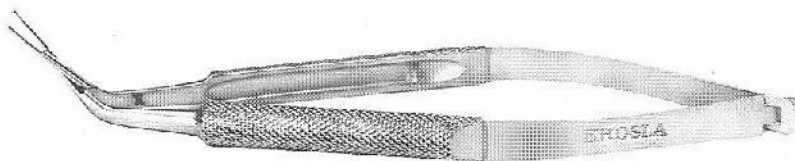

Soft IOL Inserting Forceps
K-2833

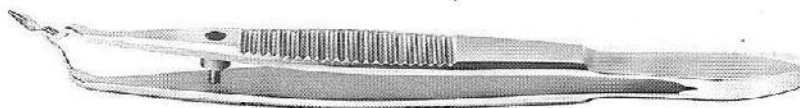

STEINERT
Universal Folding Forceps
For Acrylic & Silicone Lenses
K-2839

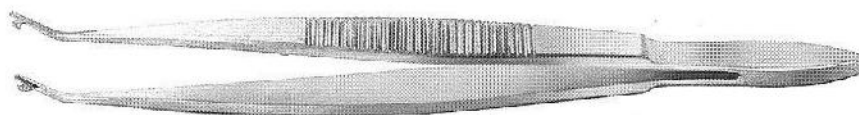

FINE
Inserting Forceps
For Acrylic & Silicone Lenses
K-2840

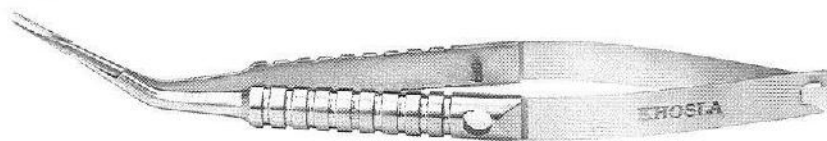

KOCH
Universal Lens Folder
For Silicone Lenses
K-2841

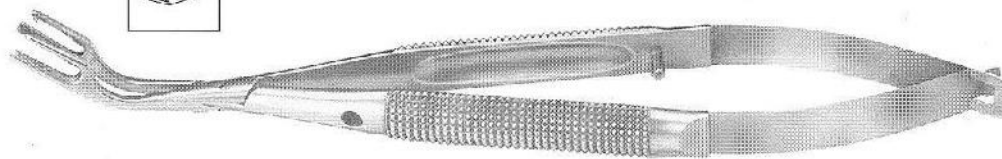



forceps

ERNEST
Nucleus Cracker
K-2838

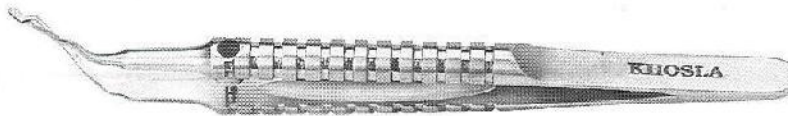

PRE-CHOPPER
Sharp Tips Maximum Opening 2.8mm
K-2836/S Straight
K-2836/A Angled



**PRE-CHOPPER FOR
SOFT CATARACTS**
Wider Jaws Help
Split Soft Nucleus
Very Soft Tip
Maximum Opening 2.8mm
K-2837/S Straight
K-2837/C Curved
K-2837/A Angled



BERKE

Ptosis Clamp, 20mm
K-2916

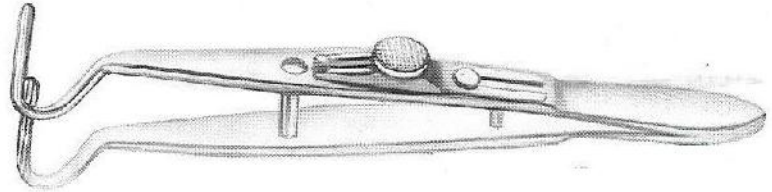

SNELLEN

Entropium Forceps
K-2917/R Right
K-2917/L Left

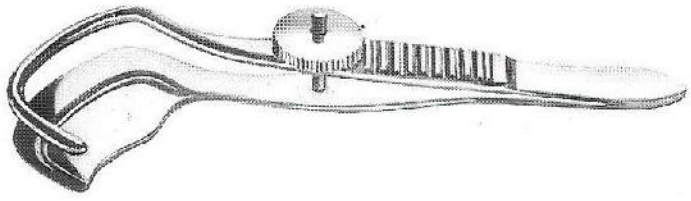

AYER

Chalazion Forceps
K-2920 Without Stop Screw
K-2921 With Stop Screw

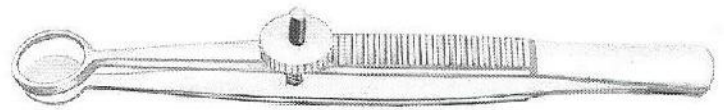

LAMBERT

Chalazion Forceps
K-2922

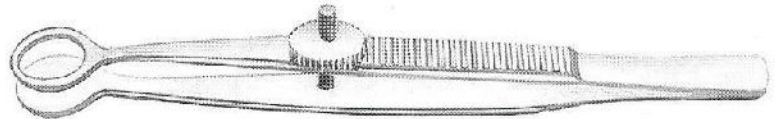

HUNT

Chalazion Forceps
K-2927

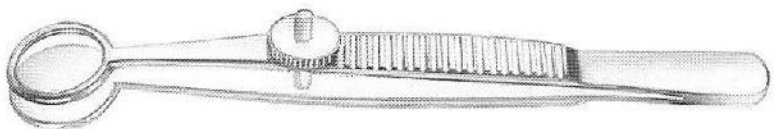



forceps

DESMARRES

Chalazion Forceps, Oval

K-2923/0 15mm

K-2923/1 20mm

K-2923/2 26mm

K-2923/3 31mm

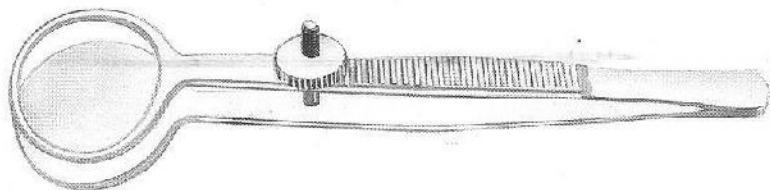

ERHARDT

Lid Forceps

K-2926

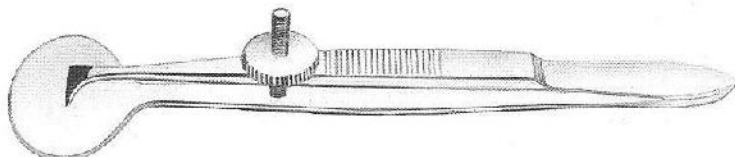

HEATH

Chalazion Forceps

K-2928

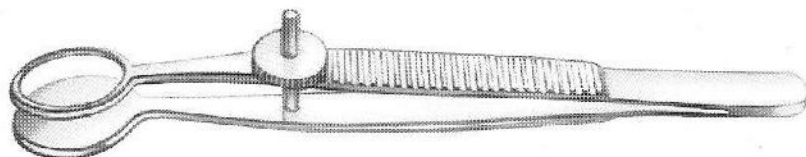

LORDAN

Chalazion Forceps

K-2930

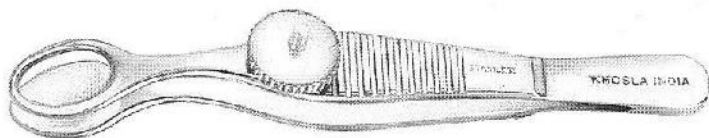

COAPTATION

Bipolar Forceps,
Fine Tips, Non-insulated
K-2931

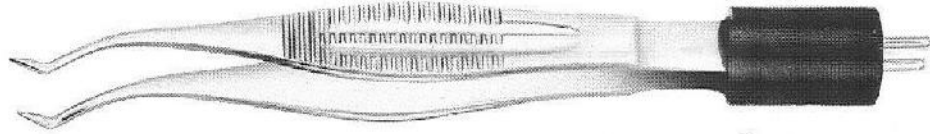

McPHERSON

Bipolar Forceps,
Straight, Non-Insulated
K-2932 / Straight
K-2933 / Angled

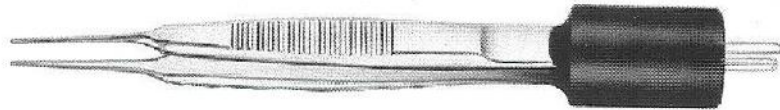

COLIBRI

Bipolar Forceps,
Angled Tip, Non-Insulated
K-2934

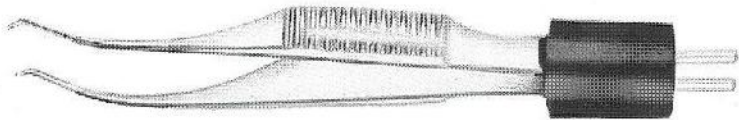

JEWELERS

Bipolar Forceps,
Straight Tip, Non-Insulated
K-2935

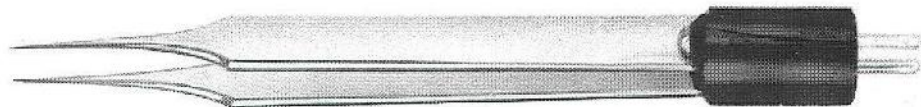



forceps hoskine

PIERSE-HOSKIN

Fixation Forceps
K-3710

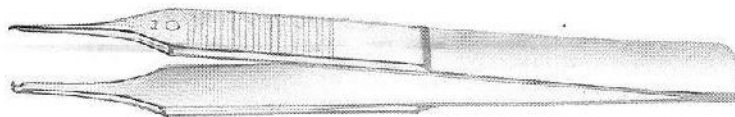

PIERSE-HOSKIN

Fine Forceps, Straight
K-3711

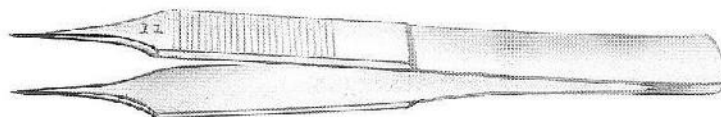

PIERSE-HOSKIN

Large Forceps, Angled
K-3714

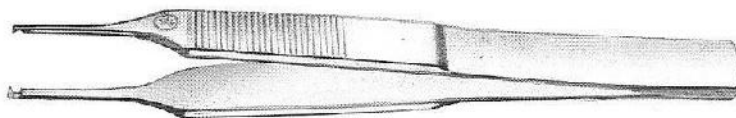

PIERS-HOSKIN

Micro Forceps, Straight
K-3715

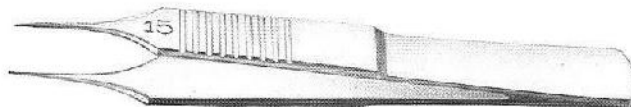

PIERSE-HOSKIN

Micro Forceps, Curved
K-3716

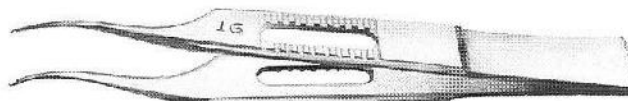

PIERSE-HOSKIN

Suture Forceps

K-3717



PIERSE-HOSKIN

Skeleton Fine Forceps

K-3718



PIERSE-HOSKIN

Skeleton Micro Forceps

K-3719

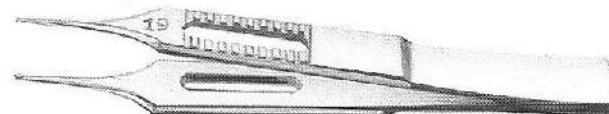

PIERSE-HOSKIN

Skeleton Fixation Forceps

K-3720

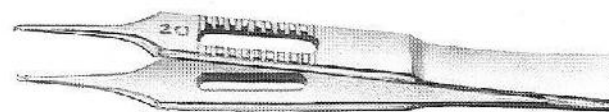

PIERSE-HOSKIN

Fine Beaked Colibri Forceps

K-3721

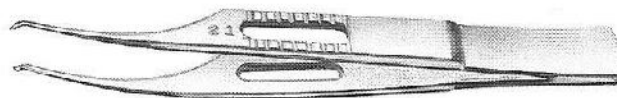

PIERSE-HOSKIN

Fine Beaked Micro Colibri Forceps

K-3722





SCISSORS

IRIS SCISSORS 3 1/2"

- K-3000** Straight
- K-3001** Curved
- K-3002** Angular

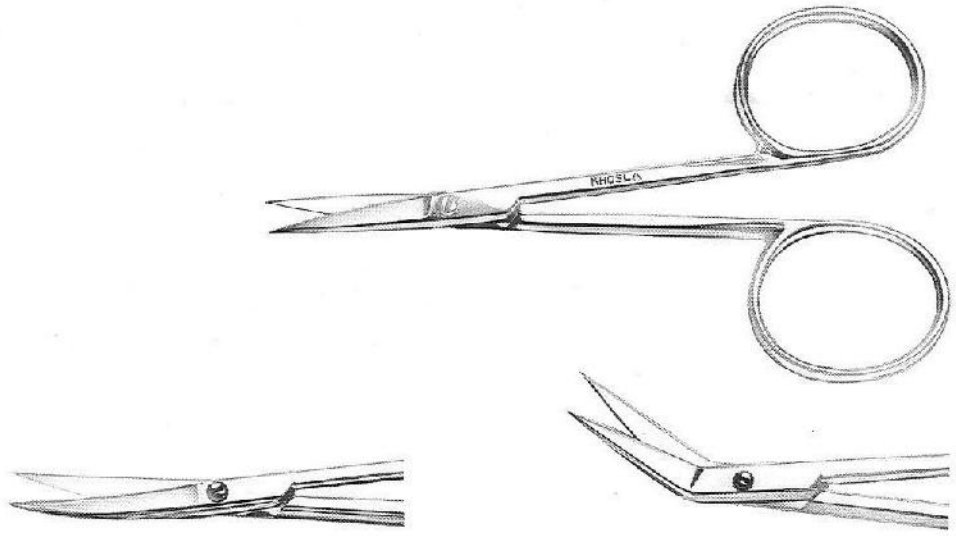

IRIS SCISSORS 4 1/8"

- K-3003** Straight
- K-3004** Curved

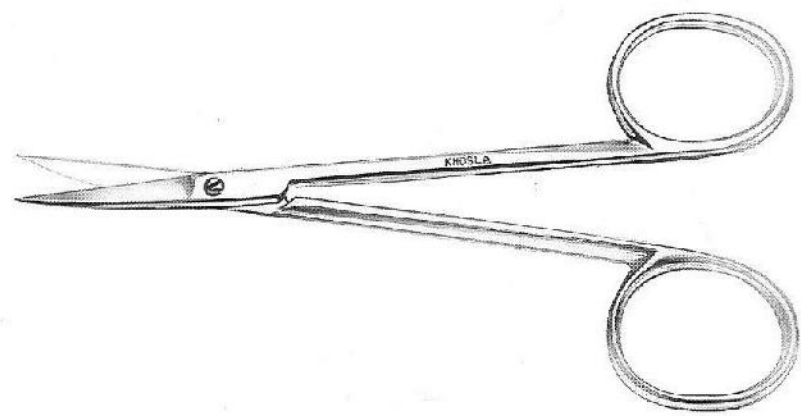

IRIS SCISSORS 4 1/2"

- K-3005** Straight
- K-3006** Curved

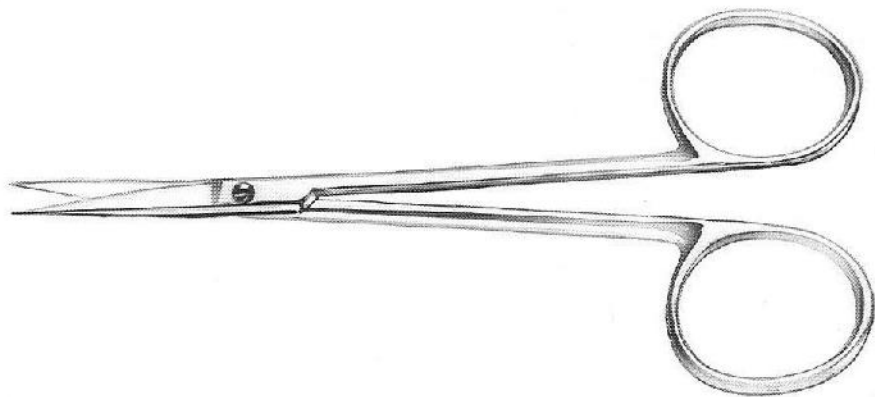

KNAPP

Iris Scissors 4 1/2"

K-3007/S Straight, Sharp & Blunt Points

K-3007/C Curved, Sharp & Blunt Points

K-3008/S Straight, Two Blunt Points

K-3008/C Curved, Two Blunt Points

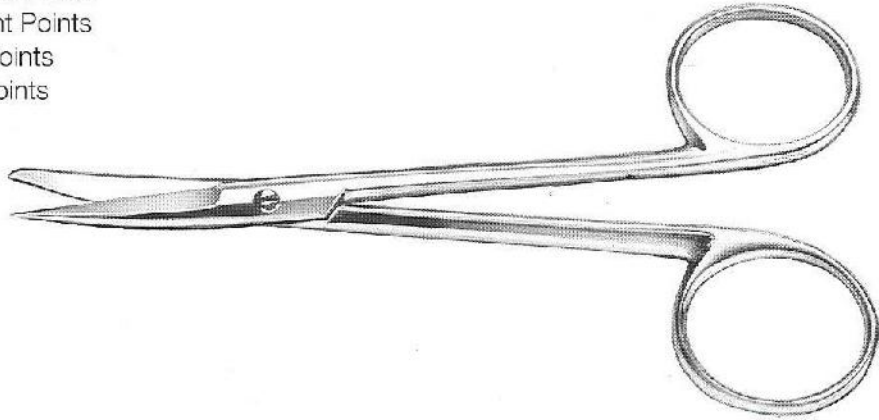

EYE SCISSORS 5" POINTED

K-3009 Straight

K-3010 Curved

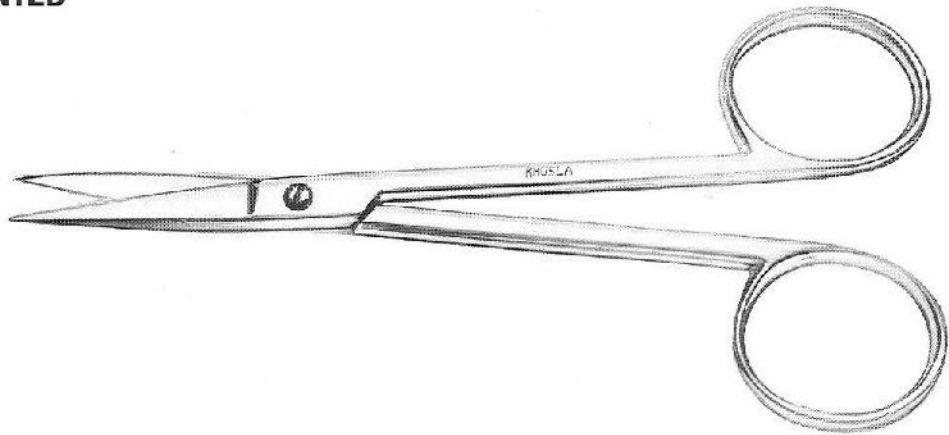



Scissors

EYE SCISSORS 5" BLUNT

K-3011 Straight

K-3012 Curved

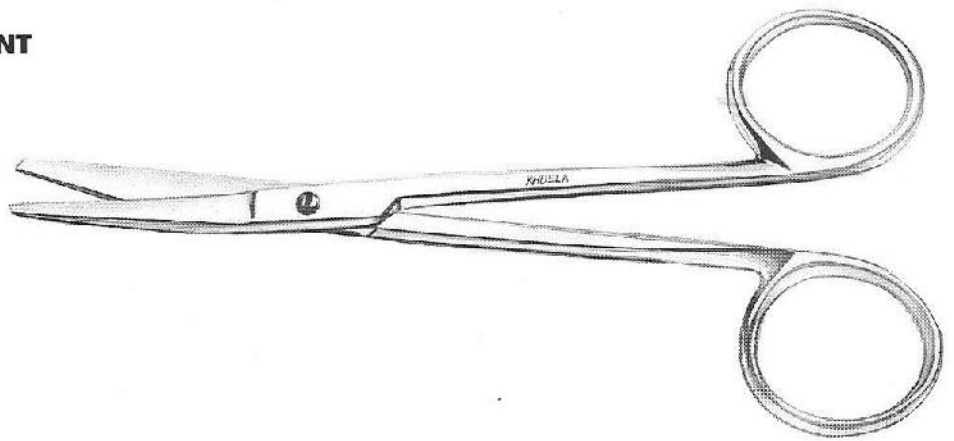

STRABISMUS SCISSORS

K-3013 Straight

K-3014 Curved

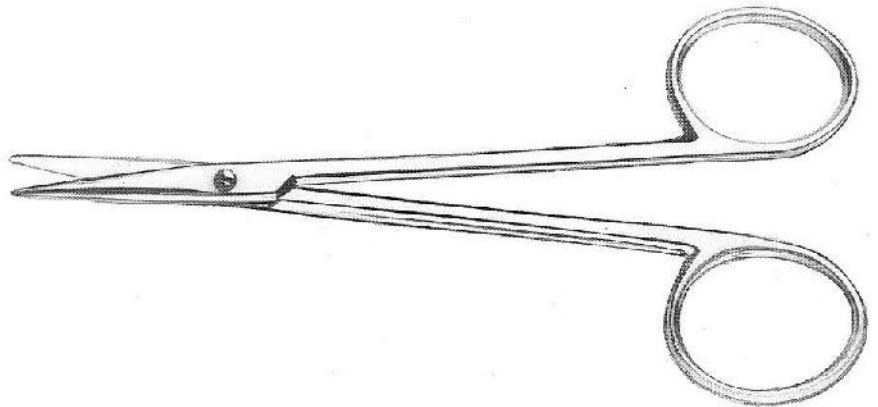

KNAPP

Strabismus Scissors

K-3015 Straight

K-3016 Curved

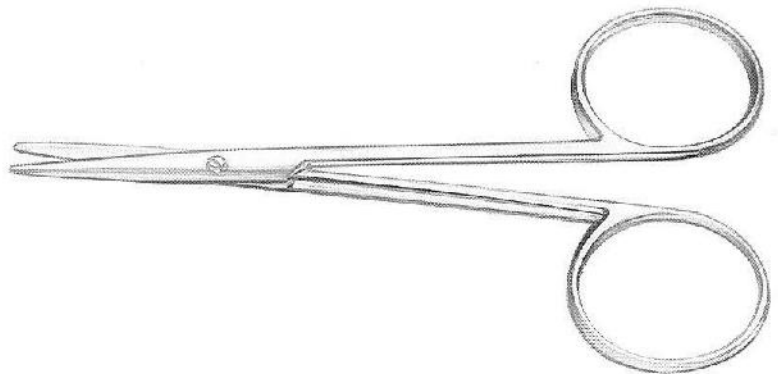

STEVENS

Tenotomy Scissors, New Model

K-3022 Straight, Blunt

K-3023 Straight, Pointed

K-3024 Curved, Blunt

K-3025 Curved, Pointed

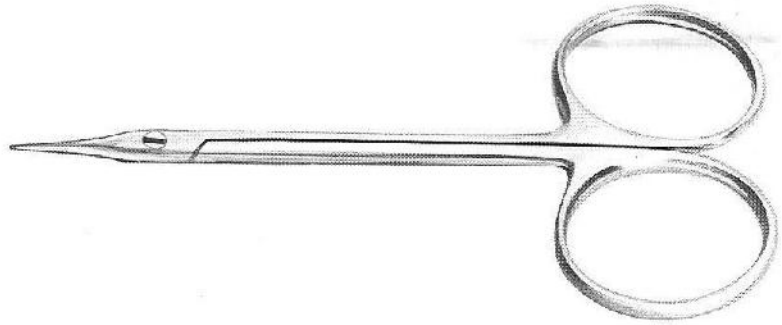

STEVENS

Tenotomy Scissors Long Model

K-3026 Straight, Blunt

K-3027 Straight, Pointed

K-3028 Curved, Blunt

K-3029 Curved, Pointed

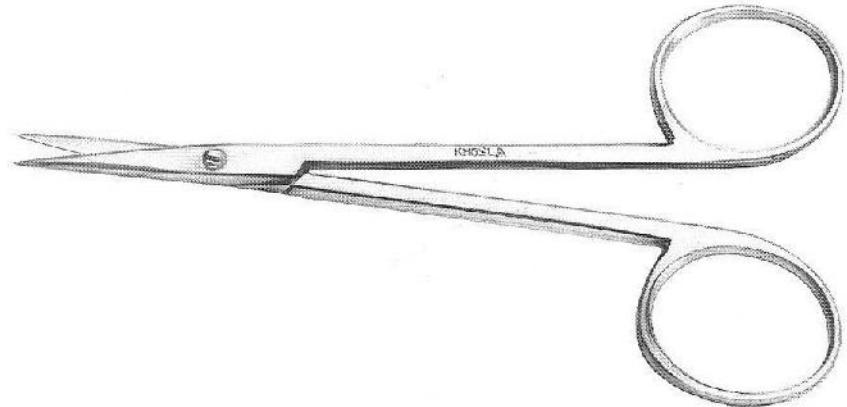

SPENCER

Stitch Scissors, 3.5"

K-3030

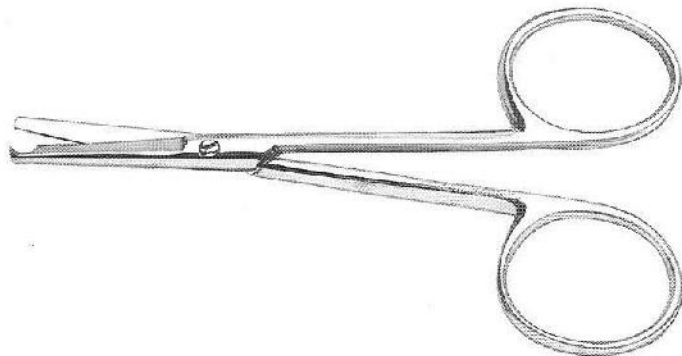

ENUCLEATION

Scissors

K-3031 Half Curved

K-3032 Full Curved

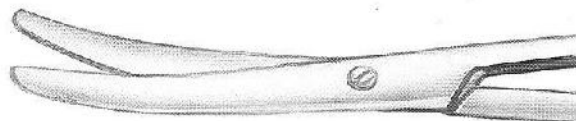
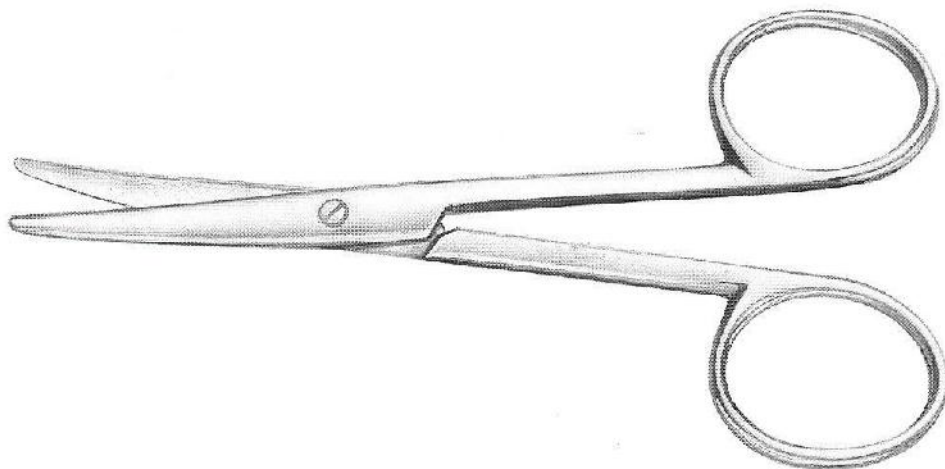

BONN MODEL

Iris Scissors, Delicate

K-3033 Curved

K-3034 Straight

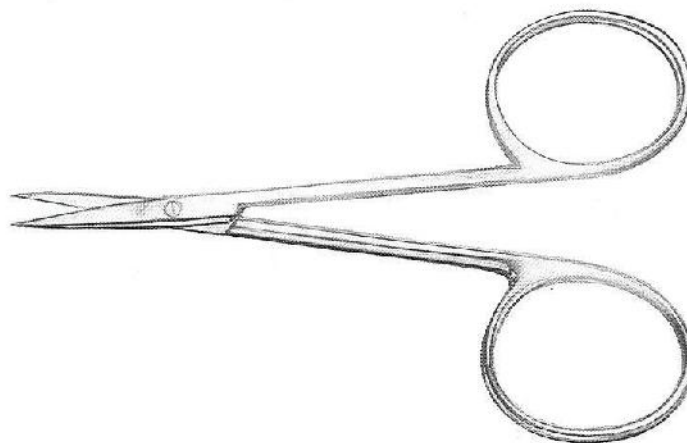

Mc GUIRE

Corneal Scissors

k-3035 Left

K-3036 Right

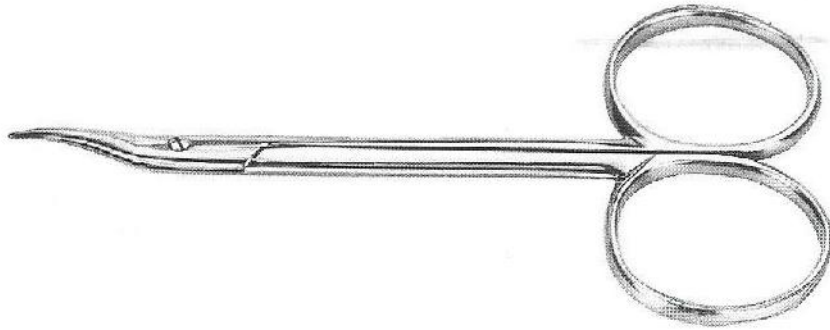

DE-WECKER

Iris Scissors

K-3037/A Sharp Tips

K-3037/B Sharp & Blunt Tips

K-3037/C Blunt Tips

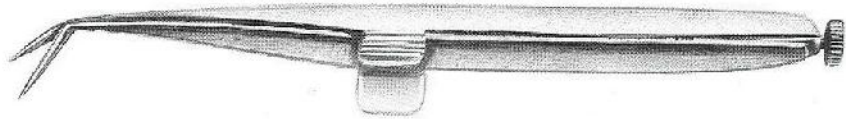

NOYES

Iris Scissors

K-3038/A Sharp Tips

K-3038/B Sharp & Blunt Tips

K-3038/C Blunt Tips



BARRAQUER

Iris Scissors

K-3040 7mm Blade

K-3041 10mm Blade



VANNAS

Capsulotomy Scissors
Very Delicate 6mm Blade

K-3042 Straight

K-3043 Curved

K-3045 Angled On Side

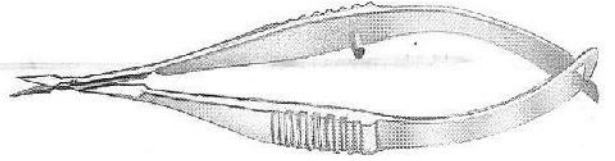

GILLS-WELSH VANNAS

Capsulotomy Scissors,
Very Delicate 11mm Blade Angled On Flat

K-3046

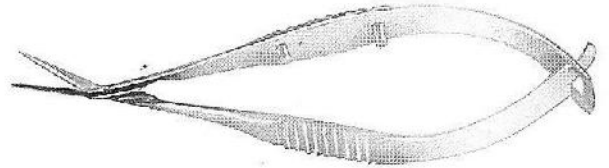

GILLS VANNAS

Capsulotomy Scissors,
Very Delicate 11mm Blade

K-3047 Straight

K-3048 Curved

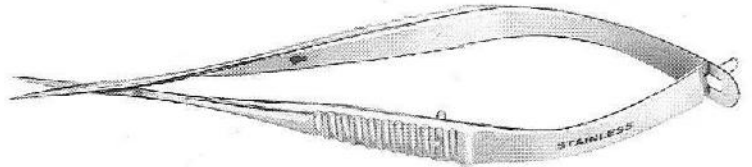

STERN-GILLS

Scissors 10mm Long Thin Sharp Blades,
Angled On Flat

K-3049

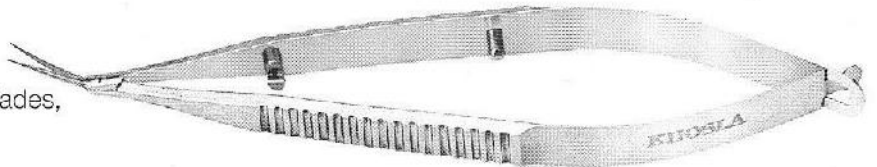

UBIRE-STERN

Scissors 10mm Long Thin Sharp Blades,
Curved

K-3050

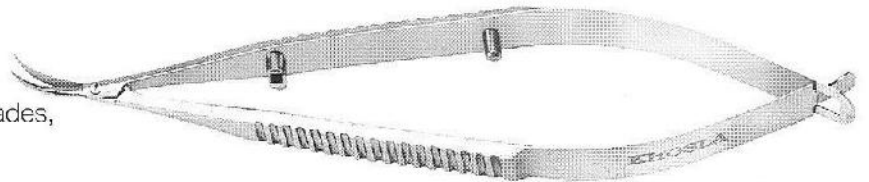

WESTCOTT

Tenotomy Scissors,
Standard Blades
K-3100 Blunt Tips
K-3101 Pointed Tips

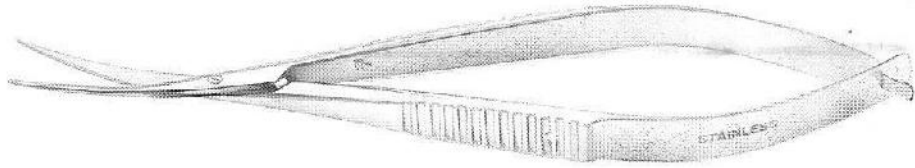

WESTCOTT

Tenotomy Scissors,
Medium Blades,
K-3100/A Blunt Tips
K-3101/A Pointed Tips

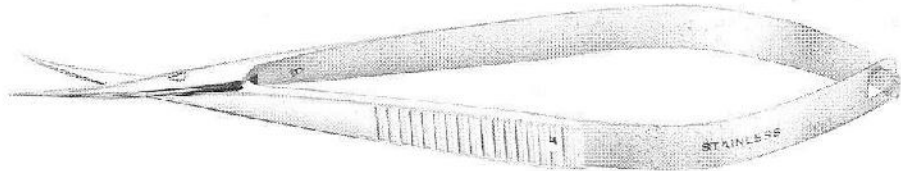

McPHERSON-WESTCOTT

Stitch Scissors, Small Blades
K-3130/A Blunt Tips
K-3130/B Pointed Tips

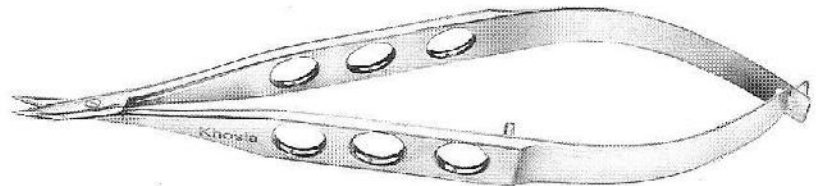

JAFFE

Stitch Scissors,
Medium Blades, Sharp Tips
K-3128

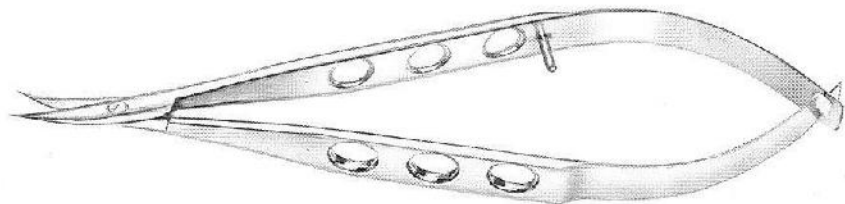



SCISSORS

CASTROVIEJO

Corneal Scissors,
Strong Curve, Blunt Tips

K-3103

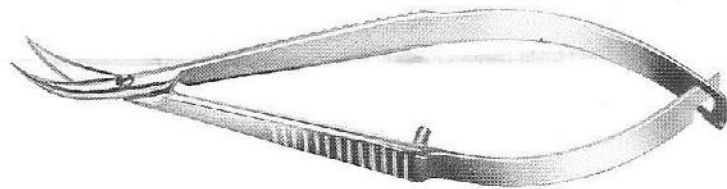

CASTROVIEJO

Corneal scissors,
Slightly Curve, Blunt Tips

K-3104

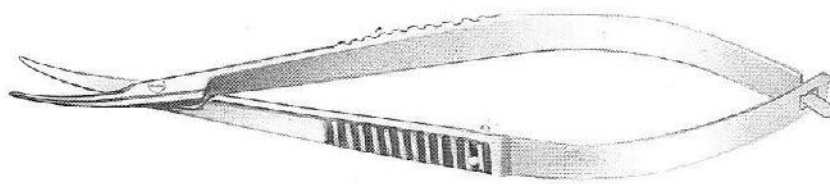

CASTROVIEJO

Minature Corneal Scissors,
K-3105 Straight

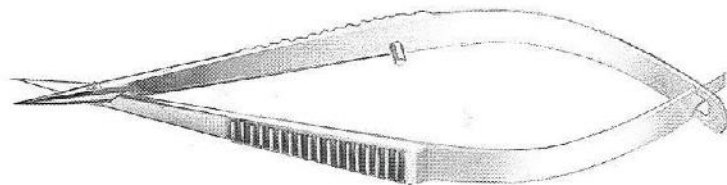

CASTROVIEJO

Minature Corneal Scissors,
K-3106 Curved

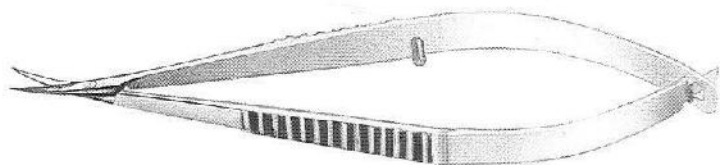

CASTROVIEJO

Minature Corneal Scissors,
Blunt Tips

K-3107 Curved

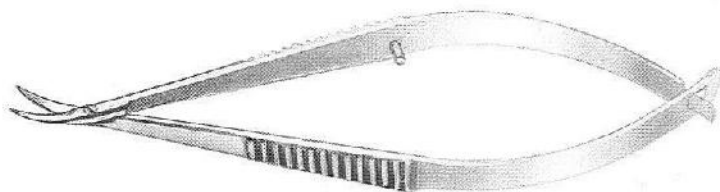

CASTROVIEJO

Minature Corneal Scissors,
Blunt Tips
K-3108 Angled

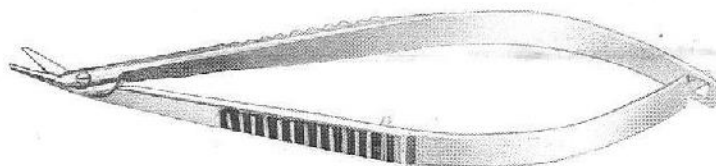

KATZIN

Micro Corneal Scissors
K-3109 Right
K-3110 Left

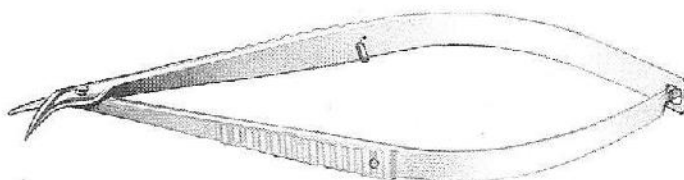

KATZIN

Corneal Transplant Scissors
Medium Blades
K-3109/A Right
K-3110/B Left

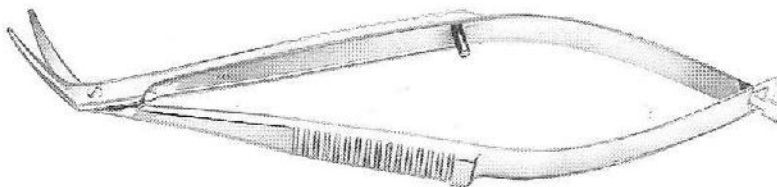

CASTROVIEJO

Corneal Scissors,
Blunt Tips
K-3115 Angled

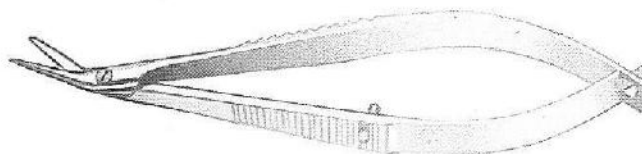

CASTROVIEJO

Corneal Scissors
K-3116 Right
K-3117 Left

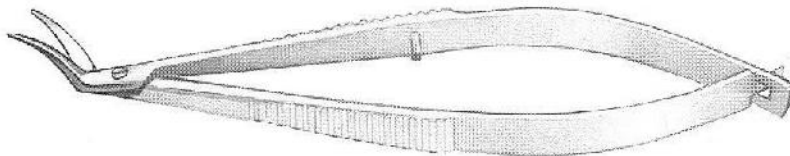



SCISSORS

CASTROVIEJO

Minature Corneal Scissors

K-3118 Right

K-3119 Left

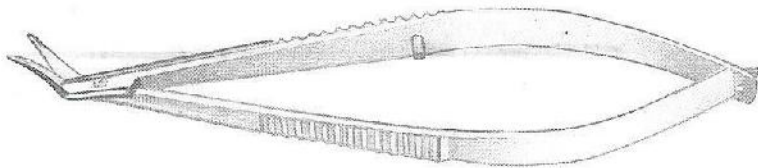

TROUTMAN-CASTROVIEJO

Micro Corneal Scissors

K-3124 Right

K-3125 Left

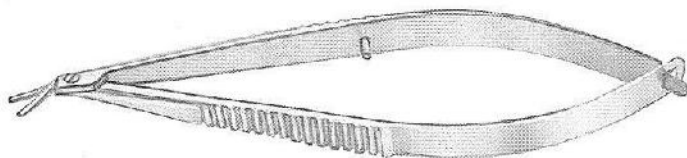

TROUTMAN-CASTROVIEJO

Micro Corneal Scissors With Stop Lock

K-3124/A Right

K-3125/A Left

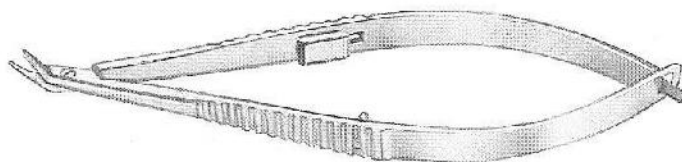

TROUTMAN-CASTROVIEJO

Comeoscleral Scissors With Stop Lock

Medium Blades

K-3124/B Right

K-3125/B Left

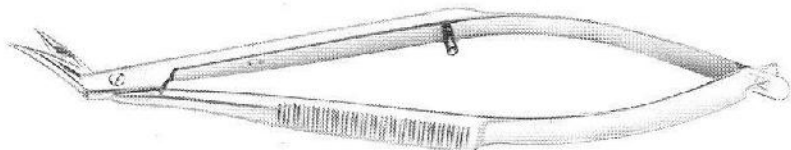

ARRUGA

Needle Holder

K-3200 Straight

K-3201 Curved

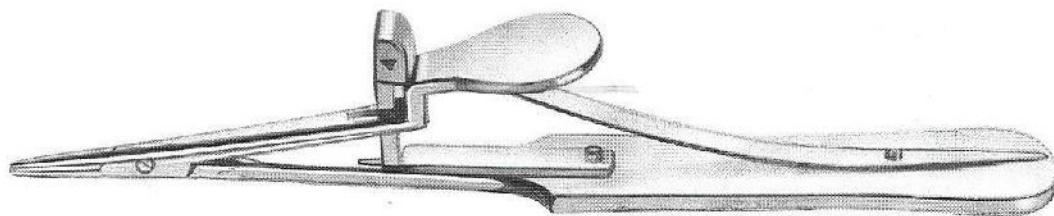

KALT

Needle Holder

K-3202 Straight

K-3203 Curved

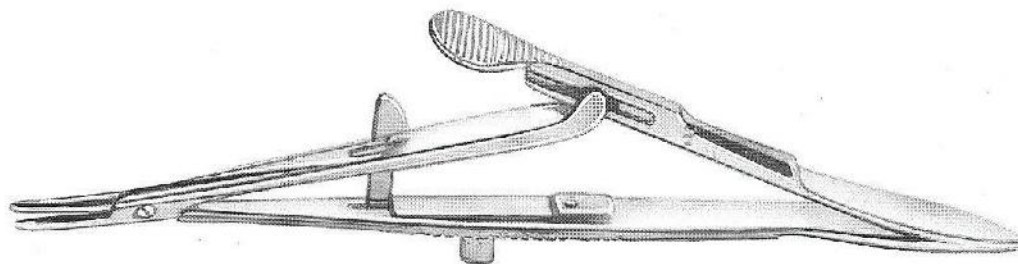

CASTROVIEJO-KALT

Needle Holder With Scissors

K-3204

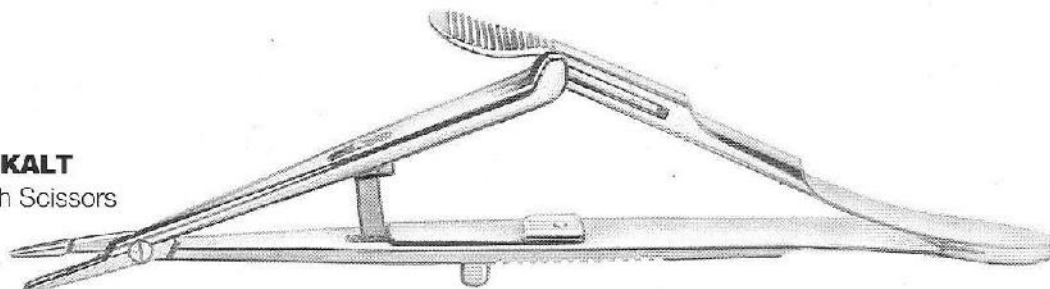

BARRAQUER

Needle Holder, Curved Without Lock 5.5"

K-3205

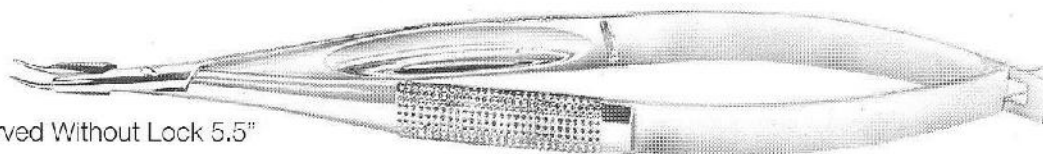

BARRAQUER

Needle Holder,
Standard Jaws Serrated With Groove, Curved

K-3206 Without Lock

K-3207 With Lock

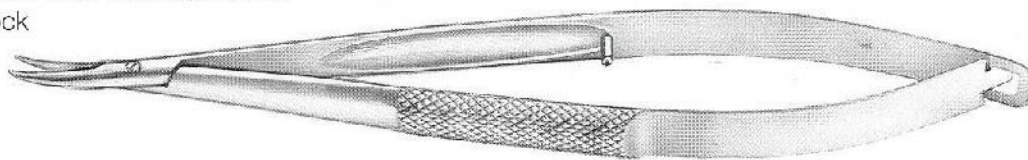

BARRAQUER

Needle Holder,
Delicate Jaws Serrated, Curved

K-3208 Without Lock

K-3209 With Lock

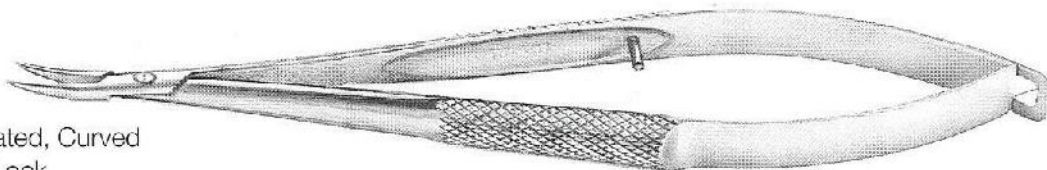

BARRAQUER

Needle Holder,
Very Delicate Smooth Jaws

K-3227/SA Straight With Lock

K-3227/SB Straight Without Lock

K-3227/CA Curved With Lock

K-3227/CB Curved Without Lock

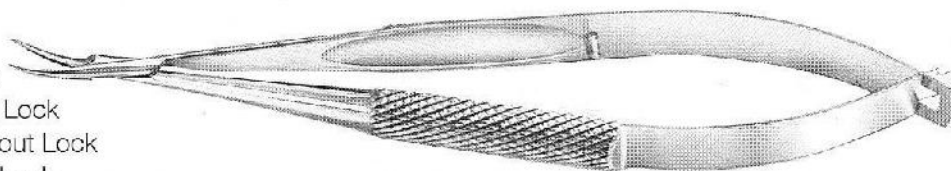

BARRAQUER

Needle Holder,
Extra Delicate Smooth Jaws

K-3228/SA Straight With Lock

K-3228/SB Straight Without Lock

K-3228/CA Curved With Lock

K-3228/CB Curved Without Lock

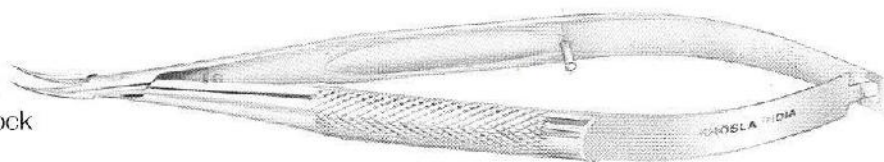

BABY BARRAQUER

Needle Holder, Delicate Jaws

K-3240/A Straight With Lock

K-3240/B Straight Without Lock

K-3241/A Curved With Lock

K-3241/B Curved Without Lock

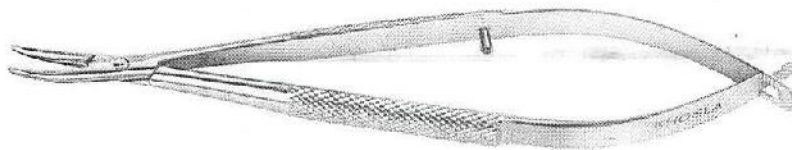

CASTROVIEJO

Needle Holder, Delicate Jaws

K-3210/A Straight With Lock

K-3210/B Straight Without Lock

K-3211/A Curved With Lock

K-3211/B Curved Without Lock

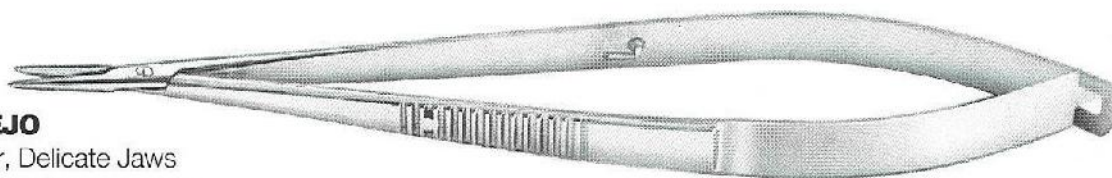

CASTROVIEJO

Needle Holder, Standard Jaws

K-3212/A Straight With Lock

K-3212/B Straight Without Lock

K-3213/A Curved With Lock

K-3213/B Curved Without Lock

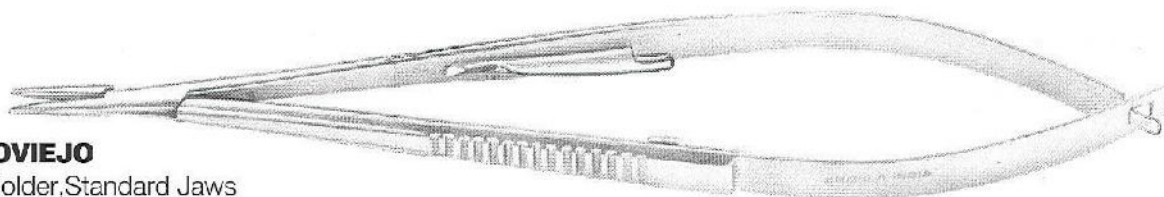



needle holders

STEVENS

Needle Holder, Straight

K-3221/A With Lock

K-3221/B Without Lock

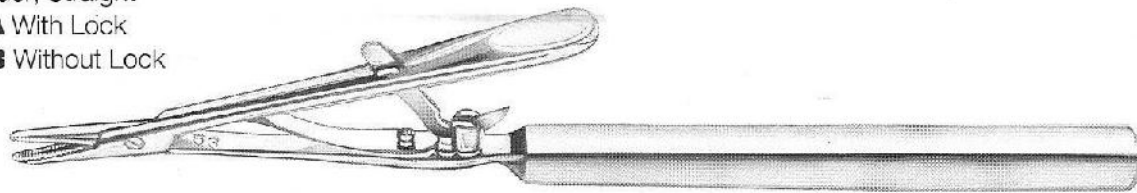

McPHERSON

Needle Holder

K-3231/A Straight With Look

K-3231/B Straight Without Look

K-3232/A Curved With Look

K-3232/B Curved Without Look

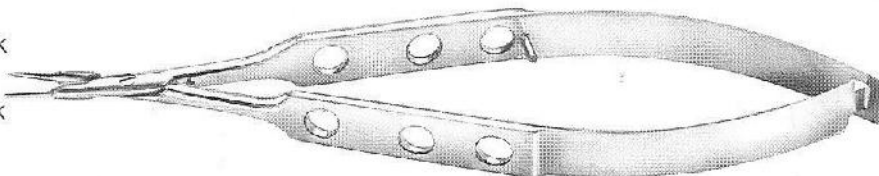

NEEDLE HOLDER

Very Delicate Jaws

K-3243/A Straight With look

K-3243/B Straight Without Look

K-3243/A Curved With Look

K-3243/B Curved Without Look

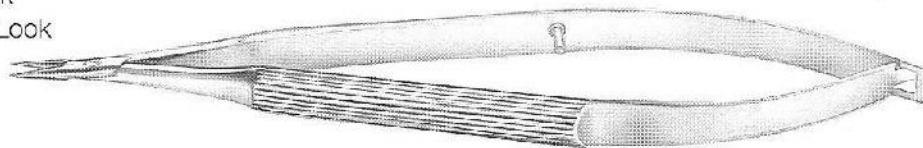

CASTROVIEJO
Blade BREAKER & Holder
K-3216

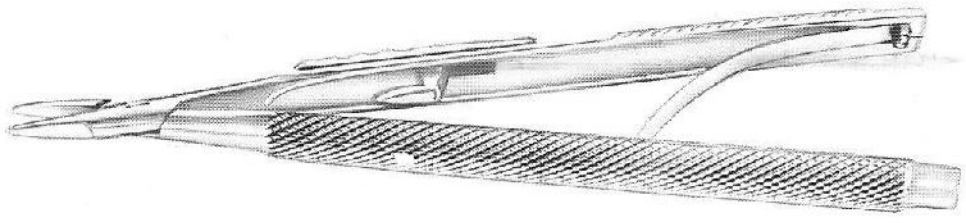

CASTROVIEJO
Blade Breaker & Holder Slim Model
K-3217

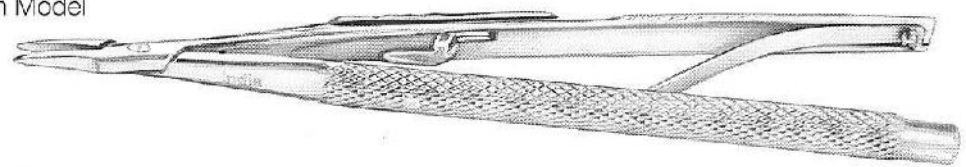

SWISS MODEL
Blade Breaker & Holder
K-3219 9cm
K-3220 12cm

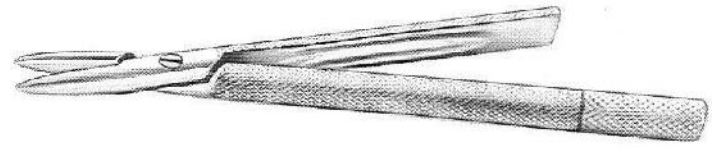

CARBON STEEL
Double Edged Blade
For Blade Breaker & Holder Box/100 Sterile
K-3223

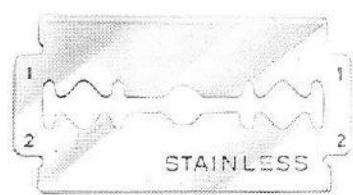

A.C. WASH
Cannula
K-2200



CASTROVIEJO
Cyclodialysis Cannula, Top Opening
K-2201 10mm
K-2202 15mm

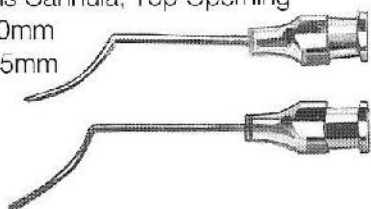

LACRIMAL
Cannula
K-2203/S Straight 23 G
K-2203/C Curved 23 G
K-2203/S Straight 20 G
K-2203/C Curved 20 G

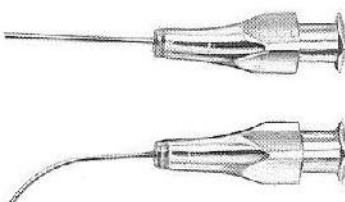

McINTYRE
Lacrimal Cannula
K-2220/S Straight 23 G
K-2220/C Curved 23 G



AIR INJECTION
Cannula Angled
K-2205/A 25 G
K-2205/B 27 G
K-2205/C 30 G



VISCOELASTIC
Aspirating Cannula, Angled 10mm
K-2221/A 19 G
K-2221/B 22 G



WELSH
Cortex Extractor Cannula
Flat Olive Tip 25 G
K-2211/L Left
K-2211/R Right
K-2221/S Straight

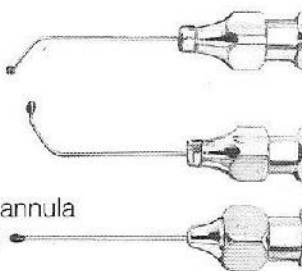

ATKINSON
Retrobulbar Needle
K-2223/A 23 G. X 35mm
K-2223/B 25 G. X 35mm
K-2223/C 27 G. X 35mm

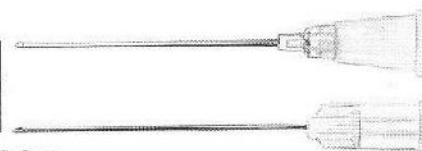

SIMCOE

Irrigating Aspirating Cannula 23 G.

K-2218 Regular

K-2218/A Reverse

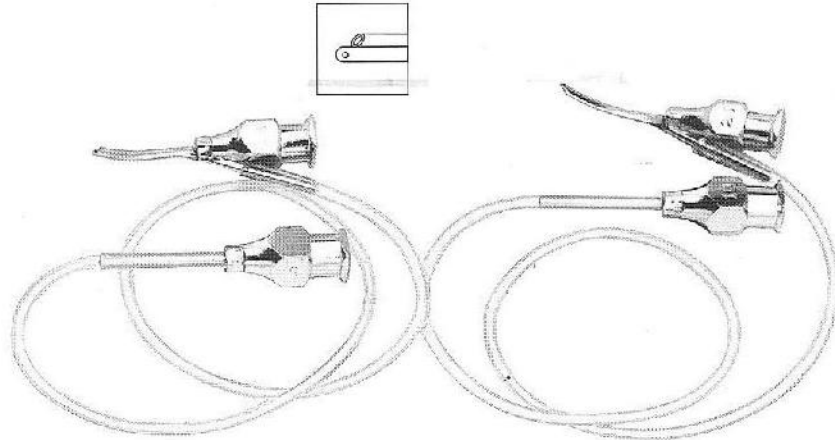

DALJIT

Irrigation Aspiration Cannula

K-2222

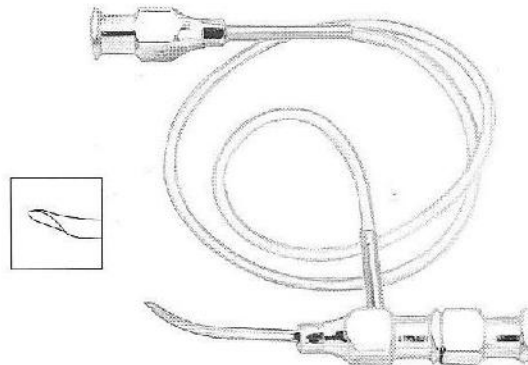

SIMCOE

Irrigation Aspiration 12'0' Clock Cannulas

2218/RC Right

2218/LC Left

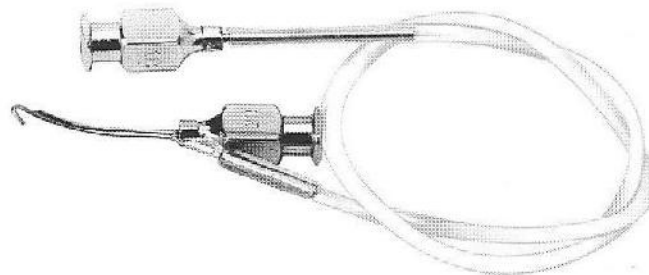

GILLS

Irrigating Aspirating Cannula 23 G.
K-2227

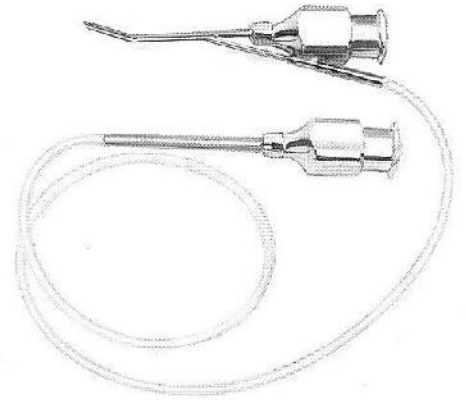

GRANDON

Irrigating Aspirating cannula 23 G.
K-2228

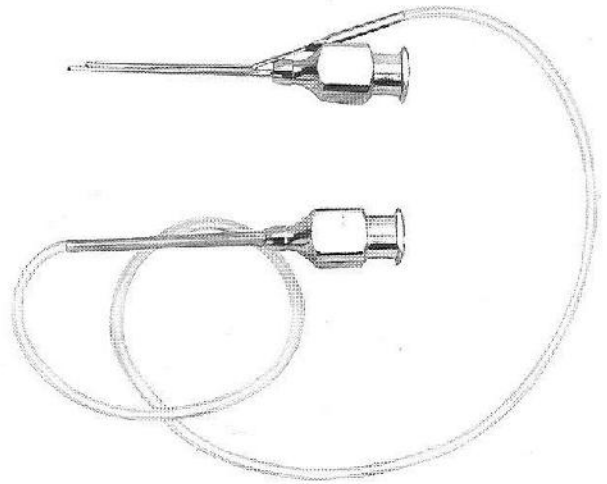

BISHOP-HARMON

Anterior Chamber Irrigator 19 G.
Cannula, Adaptor 7 Silicone Bulb
K-2219 Complete Set
K-2219/A Adaptor
K-2219/B Silicone Bulb
k-2219/C Cannula 19 G.

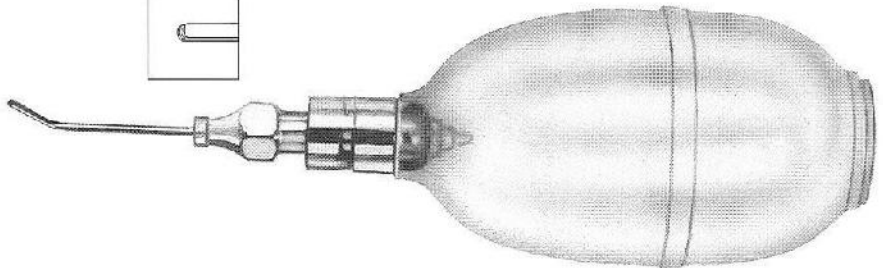



KELMAN

Cystotome, Dowde sharp 226
K-2258



KRATZ

Cystotome, Sharp 226
K-2217



DREWS

Cystotome, Angled
K-2260/1 27G
K-2260/2 30G

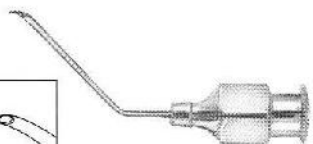

Irrigating Cystotome
Angled 27G
K-2262



McIntyre
Infusion Handle 3"
K-2276

KANSAS

Infusion Handle 3"
K-2275



Irrigating Cystotome
Straight

K-2263/1 23G
K-2263/2 25G
K-2263/3 27G
K-2263/4 30G

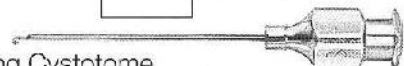

Irrigating Cystotome
Formed

K-2267/1 23G
K-2267/2 25G
K-2267/3 27G
K-2267/4 30G



HEALON

Cannula 21G
K-2271



KNOLLE

Anterior Chamber Irrigating Cannula
2mm Angled Tip
K-2230/1 23G
K-2230/2 30G

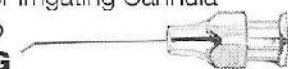

Anterior Chamber Maintainer
Lightly Roughened Tip, 20G
K-2278

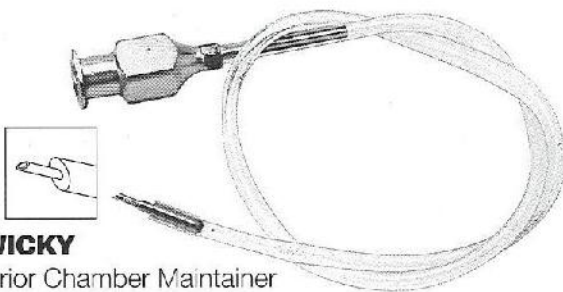
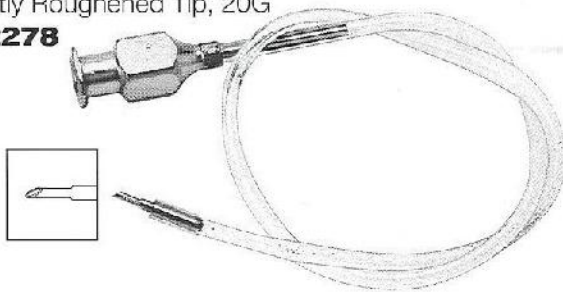

LEWICKY
Anterior Chamber Maintainer
Unique Annular rings for
self retaining, 3.5mm Cannula
20G
K-2287

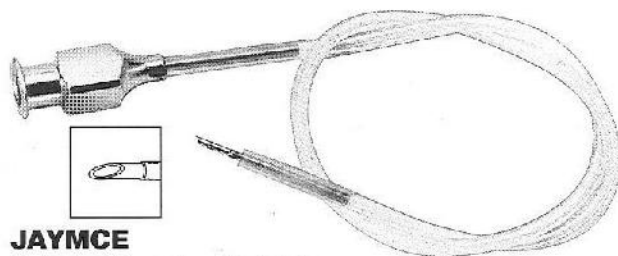

JAYMCE
Anterior Chamber Maintainer
Bulbous Tip allows easy insertion
& minimum tissue disturbance
4mm Cannula, 20G
K-2288

HYDRO-DISSECTION
Cannula "J" Shaped Tip 25G
K-2232

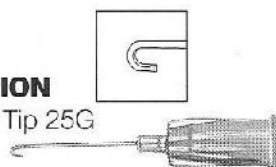

HYDRO-DISSECTION

Cannula Angled Flat Spatulated Tip, 7mm
K-2233/1 25G
K-2233/2 27G

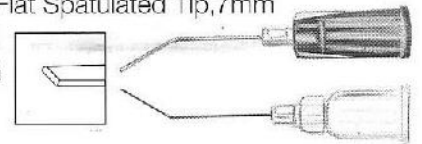

KELLAN

Hydro-Dissection Cannula
Angled Flat Blunt Tip, 11mm
K-2235/1 25G
K-2235/2 30G

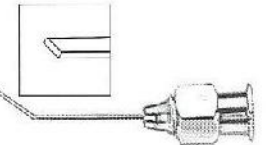

KELLAN

Hydro-Dissection Cannula
Curved, Bevelled Tip, 25G
K-2236

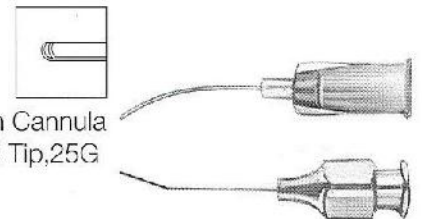

PEARCE

"J" Shaped Micro Hydro Dissector
Cannula, Hook 2mm long
K-2237/1 25G
K-2237/2 27G



FEASTER

Nucleus Hydrolineator Cannula
Closed Tip allows easy
penetration between
nucleus and epinucleus.
Two Irrigating Ports for
fluid distribution in
both the planes, 25G
K-2289

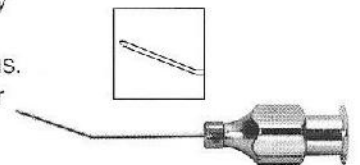

McIntyre Binkhorst

Cortex Aspirating Cannula
Blunt Tip, Front Opening, 26G
K-2290/L Left
K-2290/R Right

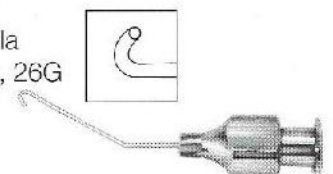

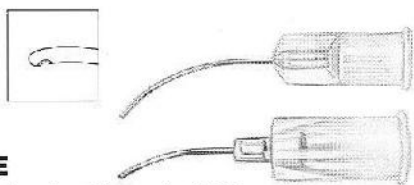

SIMCOE

Cortex Extractor Cannula 23G

K-2216/1 Short Model

K-2243/2 Long Model

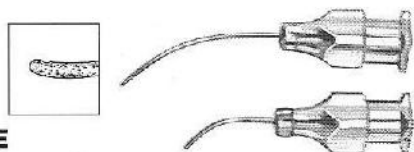

SIMCOE

Cortex Extractor & Capsule Polisher Cannula, Sand Blasted Tip, 23G

K-2239/1 Short Model

K-2239/2 Long Model



WELSH

Simcoe Cortex Extractor Cannula 10mm Tip, 0.3mm port, 23G

K-2214



JENSEN

Capsule Polisher Cannula

Olive Tip

K-2241/1 23G

K-2241/2 25G



KRATZ

Capsule Polisher Cannula

Opening, Angled

K-2242/1 21G

K-2241/2 23G



KNOLLE

Posterior Capsule Polisher Cannula
2mm Angled Tip, Front Opening

K-2243/1 23G

K-2243/2 30G



GRAETHER

Collar Button Capsule Polisher

& F. Retractor With Side Irrigation

K-2255/S Straight

K-2255/A Angled

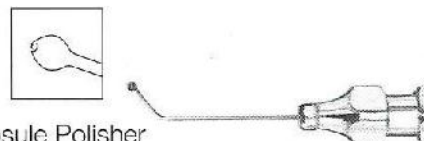

PEARCE

Olive Tip Capsule Polisher
0.3mm Top Port, 25G

K-2291

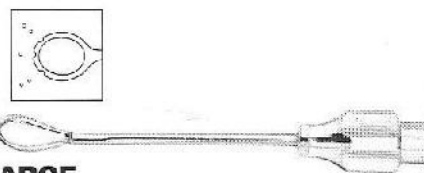

KNOLLE-PEARCE

Irrigating vectis

3 Front Ports, 23G Loop

K-2245



DREWS

Irrigating Vectis

1 Front & 2 Back Opening

Ports, 23G Loop

K-2246



cannulas



SHEETS

Irrigating Vectis
3 large Front Ports, 20G Loop Serrated
K-2247



ANIS

Irrigating vectis, 2 Front Ports, 23G
K-2248



SIMCOE

Irrigating Lens Nucleus Loop
2 Front Ports 25G, Finely Serrated
K-2249/R Right
K-2249/L Left

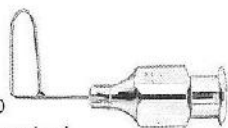

McIntyre

Small Incision Nucleus Delivery
Cannula with Spoon
3mm/4.5mm width, 23G
K-2292



Infusion Cannula

Beveled Tip, 20G
K-2293/A 2.5mm tip
K-2293/B 4.0mm tip
K-2293/C 6.0mm tip

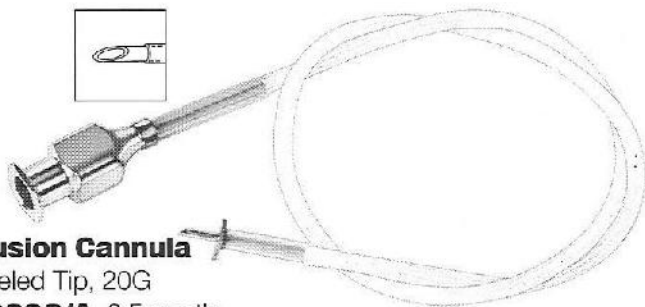

PEYMAN

Silicone Oil Cannula
For injection or aspiration
of Silicone oil in the repair
of retinal detachment 16G
K-2294



GRIZZARD

Subretinal Fluid Cannula
20G X 22mm Sleeve extends
6mm beyond end
Flexible Tip allows atraumatic entry
through a retinal tear
K-2295/S Straight
K-2295/C Curved



VANDER

Vitreoretinal Injection Cannula
20G X 1" Cannula with 30G X 5mm tip
K-2296/S Straight
K-2296/A Angled 45°

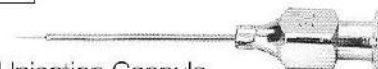

GLASER

Subretinal Injection Cannula
20G X 25mm Cannula with
32G X 3mm tip
K-2297/S Straight
K-2297/C Curved

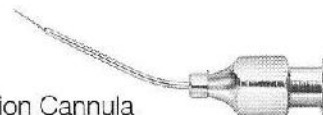

LASIK

Flap Irrigator

Cannula with 2 angled parallel tips each with 4 ports.

Simultaneously irrigates both sides of the Lasik flap and cleanses the stromal bed for flap

K-2298

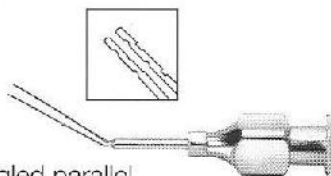

LASIK

Irrigating Cannula

Irrigation by four 0.2mm ports

K-2299/1 25G

K-2299/2 27G

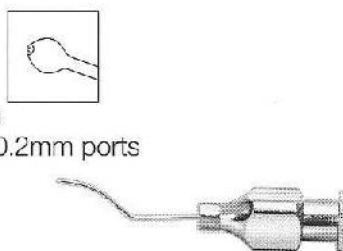

LASIK

Irrigating Cannula

Flattened Tip and formed to the curvature of the cornea.

1 front Port & 2 Side Ports.

K-2212

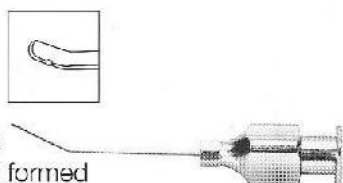

SUB-TENON'S

Anesthesia Cannula, Tri. point

K-2264/A 19G Angled

K-2264/C 19G Curved

K-2265/A 21G Angled

K-2265/C 21G Curved

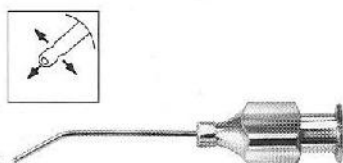

SUB-TENON'S

Anesthesia Cannula

Curved, flattened Tip 19G

K-2266

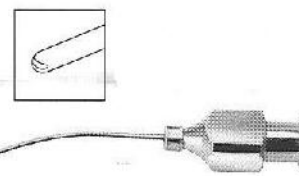

SUB-TENON'S

Anesthesia Cannula

Smooth Tip

0.3mm Sideport, 21G

K-2268

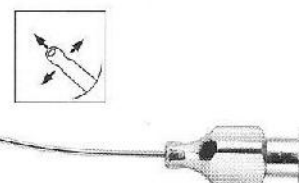

KELMAN

Cystotome, Straight, Sharp, 22G

K-2256

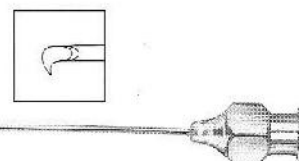

KELMAN

Cystotome, Sharp Points

Blunt Blades, 22G

K-2257

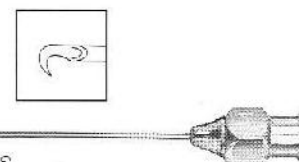

KHOSLA

K-3500

Illuminated Trial Lens Set

An Attractive Set Of Trial Lenses Worked To A High Standard Of Accuracy. The Lenses Are Of Plano Form, Back Vertex Power, 20mm Aperture Spun Into Aluminium Mounts Of 38mm Diameter. The Plus And Minus Mounts Are Anodised In Different Colours. Handles Are Provided On Spheres, But Not On Cylinders And Prisms. The Case Is Made Of Seasoned Wood. The Lens Tray Rises On Lifting The Lid And The Set Is Automatically Illuminated.

CONTENTS :

32 Pairs Each Of CX. And CC. Spheres 0.12	20 Pairs Each Of CX. And CC. Cylinders 0.12
0.25 To 4.00 In 0.25 Steps	0.25 To 3.50 In 0.25 Steps
4.50 To 6.00 In 0.50 Steps	4.00 To 6.00 In 0.50 Steps
7.00 To 14.00 In 1.00 Steps	10 Prisms
16.00 To 20.00 In 2.00 Steps	.5, 1, 2, 3, 4, 5, 6, 8, 10, 12.

7 Accessories : Maddox Rod, Stenopaic Slit, Pinhole, 2 Blank Discs, Red Glass, Green Glass.



KHOSLA

K-3501

Non Illuminated Trial Lens Set

Same As Above, Without Illumination, Compact Model.

CONTENTS : Same As K-3500

KHOSLA
K-3501/A

Non-Illuminated Trial Lens Set With Lenses Mounted In Plastic Frames, Packed In Portable Leather Case.
An Attractive Set Of Trial Lenses Worked To A High Standard Of Accuracy. The Lenses Are Of Plano Form, Back Vertex Power, 20mm Aperture Spun Into Plastic Mounts Of 38mm. Diameter. The Plus And Minus Mounts Are In Different Colours. Handles Are Provided On Spheres, But Not On Cylinders And Prisms. This Tray Is Fitted In A Sleek Hand Crafted Portable Leather Case.

CONTENTS : Same As K 3500



trial lens sets

KHOSLA MINI

K-3501/B

Non-Illuminated Trial Lens Set With Lenses Mounted In Plastic Frames, Packed In Portable Leather Case.

CONTENTS :

22 Pairs Each Of CX. And CC. Spheres	8 Pairs Each Of CX. And CC. Cylinders
0.25 To 3.00 In 0.25 Steps	0.25 To 2.00 In 0.25 Steps
3.50 To 6.00 In 0.50 Steps	
7.00 To 10.00 In 1.00 Steps	

6 ACCESSORIES : Stenopaic Slip, Pinhole, Blank Disc, Red Glass, Green Glass, Plain Glass.

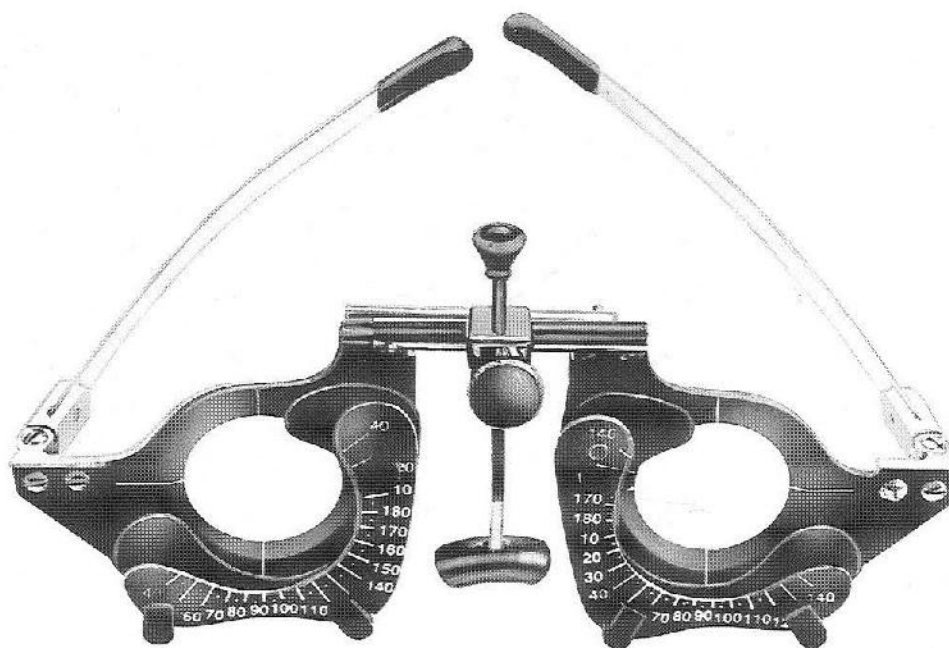

ADJUSTABLE TRIAL FRAME

K-3502

It Is A Light Weight Trial Frame With Aluminium Body And Stainless Steel Sides. The Cells Are Spaced To Accomodate Reduced Aperture Lenses Only. It Is Designed To Hold 8 Lenses And Permits Smooth And Easy Manipulation Of Bridge And P.D.

ARTIFICIAL ACRYLIC EYE

K-3600/1 Small 20mm

K-3600/2 Medium 22mm & 24mm

K-3600/3 Large 26mm & 28mm

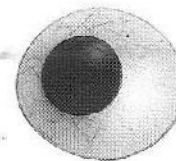

CASTROVIEJO

Acrylic Implants Sizes 13, 15, 17 & 19mm

K-3601

MULES

Sphere Acrylic Implants Sizes 10mm To 24mm Diameter

K-3602

UNIVERSAL

Conformer, Acrylic,
Small, Medium, And Large Sizes

K-3603

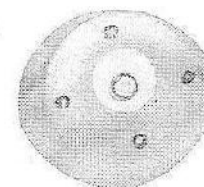
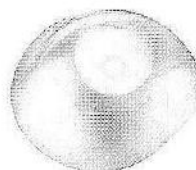

COSMETIC EYE SHELL,

Transparent

K-3605

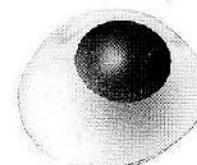

EYE SHIELD ALUMINIUM
K-3604/1

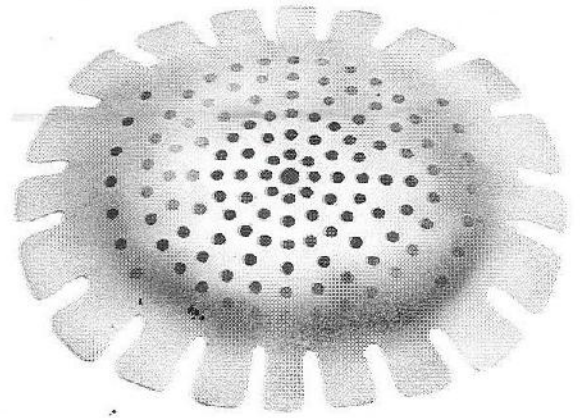

ALUMINIUM EYE SHIELD
With Garter
K-3604/2

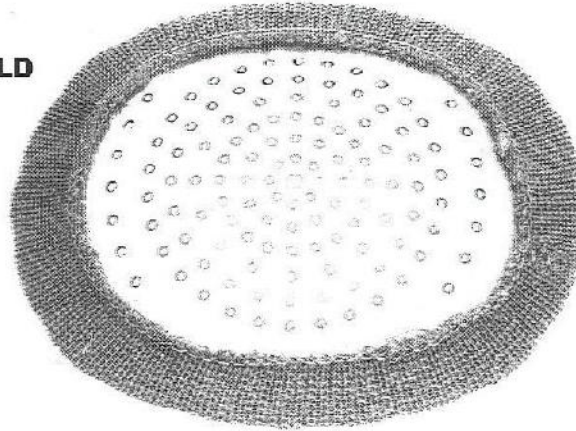

UNIVERSAL EYE SHIELD
Blue Plastic
K-3604/3

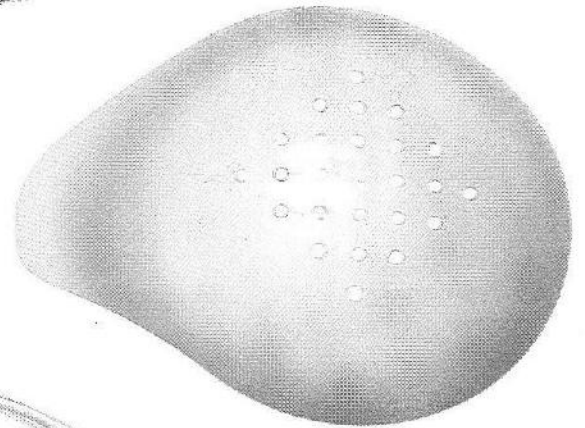

EYE SHIELD
Plastic (Auto Clavable)
K-3605/4

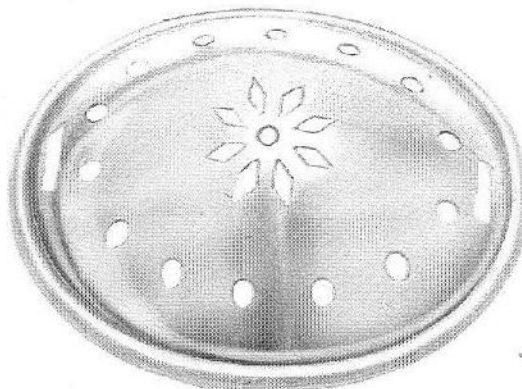

SCHIOTZ

Tonometer Certified
Calibration (Autoclavable)

K-6100

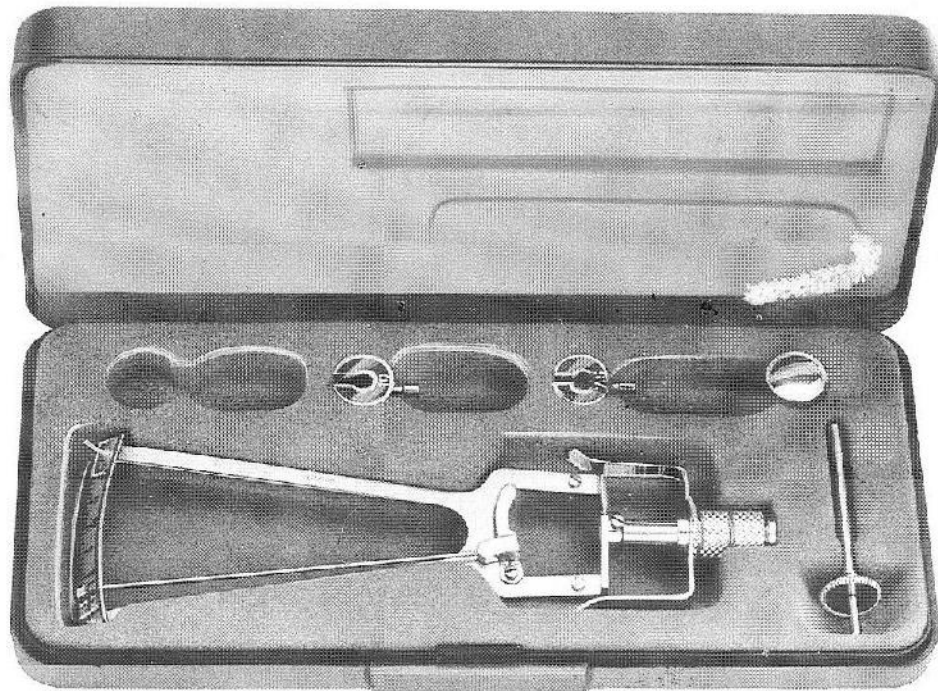

KHOSLA

Instrument Sterilizing Case, Stainless Steel Box
With Silicone Mat

K-4000 One Silicone Mat
Size 21cm X 13cm

K-4001 Two Silicone Mat
Size 26cm X 21cm

K-4002 Four Silicone Mat
Size 41cm X 25cm

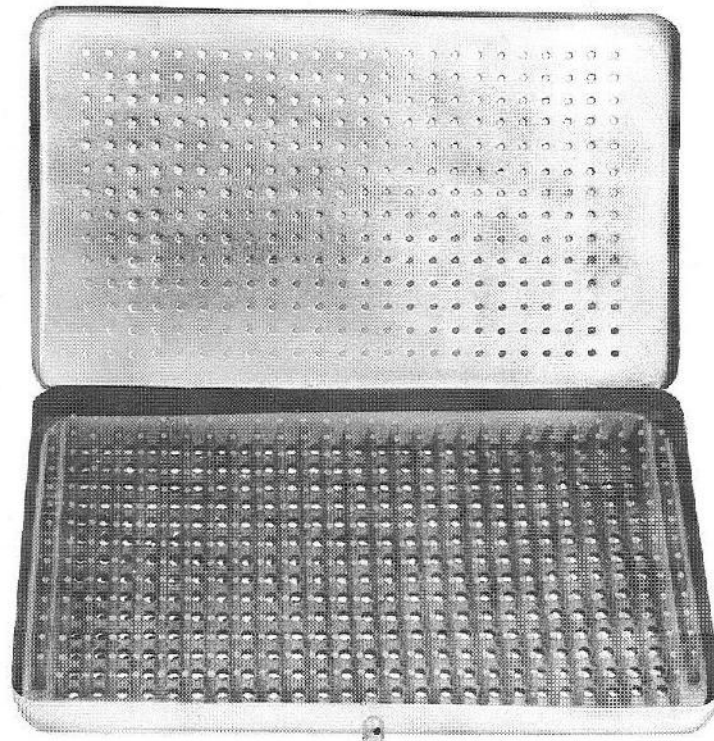



plastic sterilizing trays

KHOSLA

Plastic Sterilizing Case with silicon mat

- K-4003PL** 2.7" X 1.5" X 0.75" (Base / Mat / Lid)
- K-4004PL** 2.7" X 1.5" X 1.25" (Deep Base / Mat / Lid)
- K-4005PL** 6.0" X 2.5" X 0.75" (Base / Mat / Lid)
- K-4006PL** 6.0" X 2.5" X 1.25" (Base / Mat / Lid)
- K-4007PL** 6.5" X 4.0" X 0.75" (Base / Mat / Lid)
- K-4008PL** 7.5" X 4.0" X 0.75" (Base / Mat / Lid)
- K-4009PL** 7.5" X 4.0" X 1.50" (Deep / Base / Mat / Lid)
- K-4010PL** 10.0" X 6.0" X 0.75" (Base / Mat / Lid)
- K-4011PL** 10.0" X 6.0" X 1.05" (Deep Base / Mat / Lid)
- K-4012PL** 10.0" X 6.0" X 1.05" (Deep Base / one Mat / Insert Tray / Lid)
- K-4013PL** 10.0" X 6.0" X 1.05" (Deep Base / Insert tray / Two mats / Lid)

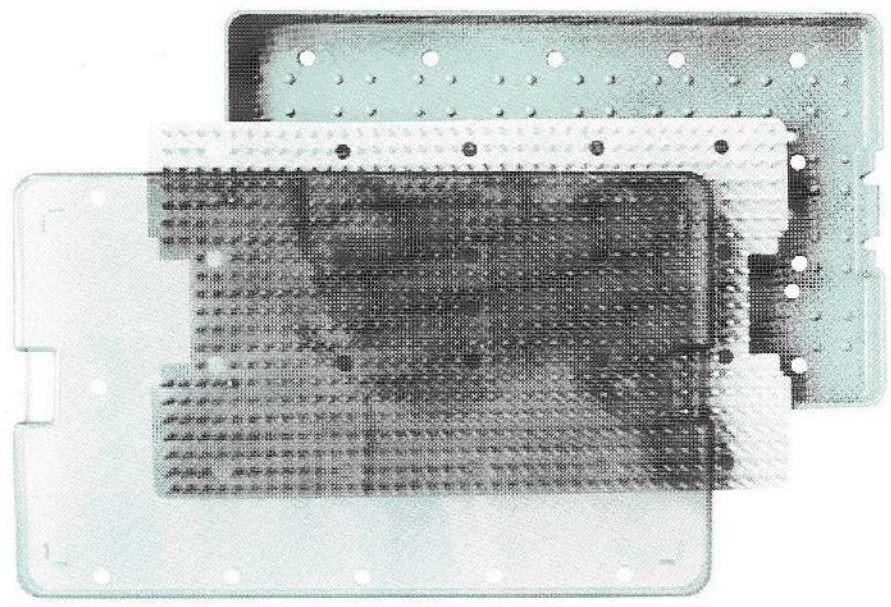

Mats / Lid)

Phaco Handpiece Trays Base and Lid Combination and Individual Silicone Mats and Silicone Insert Bars also available.





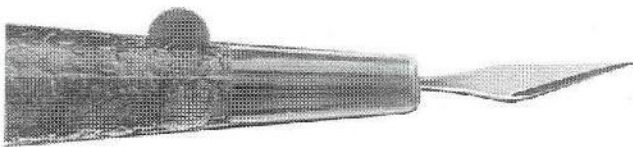

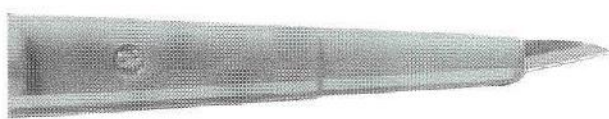
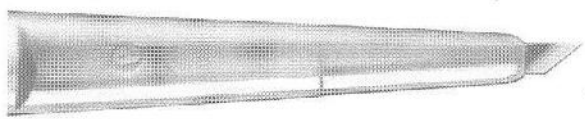



ANGLED KNIVES

EXCEPTIONALLY SHARP POINTED TIP DESIGN FOR OPHTHALMIC STAB INCISIONS AND OTHER MICROSURGICAL TECHNIQUES

	SCREW-IN BLADE	FULL HANDLE KNIFE	DESCRIPTION
	921502	AK-921501	15 Degree
		AK-921531	15 Degree, Angled Left
		AK-921541	15 Degree, Angled Right
	922202	AK-922201	22.5 Degree
	923002	AK-923001	30 Degree
	924502	AK-924501	45 Degree
	7511	AK-7512	15 Degree, 1.5 MM Depth
	7513	AK-7514	15 Degree, 3.0 MM Depth
	7515	AK-7516	15 Degree, 5.0 MM Depth
	7517	AK-7518	15 Degree, 7.0 MM Depth
	7522	AK-7523	22.5 Degree, 4.0 MM Depth
	7530	AK-7531	30 Degree, 3.5 MM Depth
	7535	AK-7536	30 Degree, 5.0 MM Depth
	7545	AK-7546	45 Degree, 3.0 MM Depth
	7550	AK-7551	45 Degree, 5.0 MM Depth

MINIATURE BLADES

SPECIFICALLY DESIGNED MINIATURE VERSIONS OF GENERAL PURPOSE SCALPEL BLADES FOR A WIDE VARIETY OF MICROSURGICAL TECHNIQUES

			
6100 Chisel Small Shaft	6200 Chisel	6300 Spear Tip	6400 Round Tip, Sharp One Side 4764 Knife Version
			
6500 Lance Tip	6700 Gradual Curved Tip	6900 Round Tip, Sharp All Around 4769 Knife Version	6910 Round Tip, Sharp All Around, Angled

CRESCENT AND SPOON KNIVES

PRECISION DESIGNED FOR OPHTHALMIC TUNNEL AND POCKET INCISIONS AND OTHER MICROSURGICAL TECHNIQUES

disposable blades

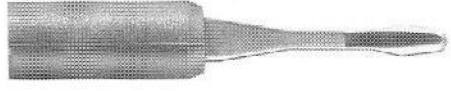
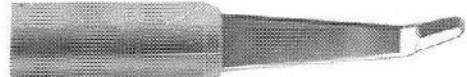
	SCREW-IN BLADE	FULL HANDLE KNIFE	DESCRIPTION
	940011	AK-940001	CRESCENT Straight
	940012	AK-940002	CRESCENT Angled, Bevel Up
		AK-940003	CRESCENT Angled, Bevel Down
		AK-940005	CRESCENT Straight, Symmetry (Double Bevel)
		AK-940006	CRESCENT Angled, Symmetry (Double Bevel)
		AK-940021	CRESCENT Straight, Slim Design
		AK-940022	CRESCENT Angled, Bevel Up, Slim Design
		AK-940023	CRESCENT Angled, Bevel Down, Slim Design
		AK-942268	SPOON 2.25 MM Angled, Symmetry (Double Bevel)
		AK-942568	SPOON 2.5 MM Angled, Symmetry (Double Bevel)
		AK-943068	SPOON 3.0 MM Angled, Symmetry (Double Bevel)
	6810	AK-6810H	SPOON 1.0 MM Small Straight
	6811	AK-6811H	SPOON 3.0 MM Medium Straight
	6812	AK-6812H	SPOON 5.0 MM Large Straight
	6820	AK-6820H	SPOON 1.0 MM Small Angled
	6821	AK-6821H	SPOON 3.0 MM Medium Angled
	6821E	AK-6821HF	SPOON 3.0 MM Medium Ext. Neck, Angled
	6822	AK-6822H	SPOON 5.0 MM Large Angled
	6825	AK-6825H	SPOON 2.5 MM Angled, Bevel Up
	4805	AK-4807	TUNNEL II Angled, Bevel Up
	4806	AK-4808	TUNNEL II Straight
		AK-4809	TUNNEL II Angled, Bevel Down
		AK-6828	EUROTUNNEL Angled, Bevel Down

SLIT KNIVES

PRECISE WIDTH SLIT DESIGN FOR OPHTHALMIC PHACO INCISIONS AND OTHER MICROSURGICAL TECHNIQUES

disposable blades

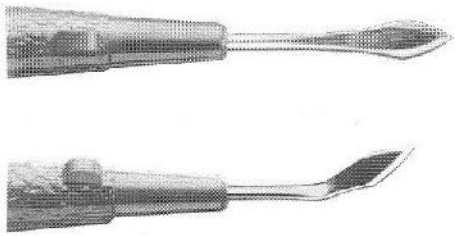
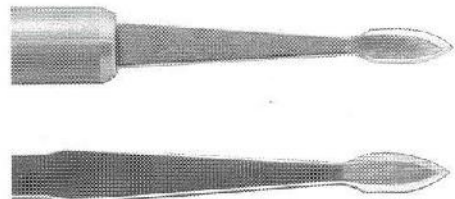
	SCREW-IN BLADE	FULL HANDLE KNIFE	SYMMETRY DOUBLE BEVEL KNIFE	DESCRIPTION	ROUND-STOCK
		Ak-902161		2.0 MM	SLIT Angled
		AK-902301		2.3 MM	SLIT Straight
		AK-902361		2.3 MM	SLIT Angled
		AK-902501		2.5 MM	SLIT Straight
		AK-902561	902568	2.5 MM	SLIT Angled
		AK-902601	902608	2.65 MM	SLIT Straight
	932662	AK-902661	902668	2.65 MM	SLIT Angled
		AK-902801	902808	2.8 MM	SLIT Straight
	932862	AK-902861	902868	2.8 MM	SLIT Angled
		AK-902901	902908	3.0 MM	SLIT Straight
	932962	AK-902961	902968	3.0 MM	SLIT Angled
		AK-903201	903208	3.2 MM	SLIT Straight
933262	AK-903261	903268	3.2 MM	SLIT Angled	
	AK-903501		3.5 MM	SLIT Straight	
	AK-903561	903568	3.5 MM	SLIT Angled	
	AK-905001		5.1 MM	SLIT Straight	
	AK-905061		5.1 MM	SLIT Angled	
	SCREW-IN BLADE	FULL HANDLE KNIFE	DESCRIPTION	FLAT-STOCK	
	5504		1.5 MM	SLIT Angled, Bevel Down	
	5505		1.5 MM	SLIT Straight	
	5510		2.5 MM	SLIT Angled, Bevel Down	
	5510BU	AK-5510HBU	2.5 MM	SLIT Angled, Bevel Up	
	5511		2.5 MM	SLIT Straight	
		AK-5540	2.65 MM	SLIT Angled, Bevel Up	
		AK-5541	2.65 MM	SLIT Straight	
	5516	AK-4740	2.8 MM	SLIT Angled, Bevel Down	
	5517	AK-4741	2.8 MM	SLIT Straight	
	5520	AK-5570	3.0 MM	SLIT Angled, Bevel Down	
	5520BU	AK-5570BU	3.0 MM	SLIT Angled, Bevel Up	
	5521	AK-5571	3.0 MM	SLIT Straight	
	5522	AK-5572	3.2 MM	SLIT Angled, Bevel Down	
	5522BU	AK-5572BU	3.2 MM	SLIT Angled, Bevel Up	
	5523	AK-5573	3.2 MM	SLIT Straight	
	5530	AK-5580	3.5 MM	SLIT Angled, Bevel Down	
	5530BU	AK-5580BU	3.5 MM	SLIT Angled, Bevel Up	
5531	AK-5581	3.5 MM	SLIT Straight		



disposable blades

IMPLANT KNIVES

EXACT WIDTH DESIGN WITH PARALLEL SIDES AND BLUNT TIP FOR OPHTHALMIC WOUND WIDENING AND OTHER MICROSURGICAL TECHNIQUES



FULL HANDLE KNIFE DESCRIPTION

FULL HANDLE KNIFE	DESCRIPTION	ROUND-STOCK
AK-903064	3.0 MM IMPLANT Angled, Blunt Tip	
AK-903264	3.2 MM IMPLANT Angled, Blunt Tip	
AK-903564	3.5 MM IMPLANT Angled, Blunt Tip	
AK-903864	3.8 MM IMPLANT Angled, Blunt Tip	
AK-904001	4.0 MM IMPLANT Straight, Blunt Tip	
AK-904061	4.0 MM IMPLANT Angled, Blunt Tip	
AK-905101	5.1 MM IMPLANT Straight, Blunt Tip	
AK-905161	5.1 MM IMPLANT Angled, Blunt Tip	
AK-905201	5.2 MM IMPLANT Straight, Blunt Tip	
AK-905261	5.2 MM IMPLANT Angled, Blunt Tip	
AK-905601	5.5 MM IMPLANT Straight, Blunt Tip	
AK-905661	5.5 MM IMPLANT Angled, Blunt Tip	
AK-906101	6.0 MM IMPLANT Straight, Blunt Tip	
AK-906161	6.0 MM IMPLANT Angled, Blunt Tip	
AK-906261	6.2 MM IMPLANT Angled, Blunt Tip	



SCREW-IN BLADE FULL HANDLE KNIFE DESCRIPTION

SCREW-IN BLADE	FULL HANDLE KNIFE	DESCRIPTION	FLAT-STOCK
4778		3.8 MM IMPLANT Angled,	Bevel Down
4778BU		3.8 MM IMPLANT Angled,	Bevel Up
4732	AK-4732	4.0 MM IMPLANT Angled,	Bevel Down
4732BU	AK-4732BU	4.0 MM IMPLANT Angled,	Bevel Up
4733	AK-4743	4.0 MM IMPLANT Straight	
4736	AK-4746	5.1 MM IMPLANT Angled,	Bevel Down
4736BU	AK-4746BU	5.1 MM IMPLANT Angled,	Bevel Up
4737	AK-4747	5.1 MM IMPLANT Straight	
5590	AK-5590H	5.2 MM IMPLANT Angled,	Bevel Down
5590BU	AK-5590HBU	5.2 MM IMPLANT Angled,	Bevel Up
5591	AK-5591H	5.2 MM IMPLANT Straight	
5594	AK-5594H	5.5 MM IMPLANT Angled,	Bevel Down
5594BU	AK-5594HBU	5.5 MM IMPLANT Angled,	Bevel Up
5595	AK-5595H	5.5 MM IMPLANT Straight	
4734	AK-4744	5.7 MM IMPLANT Angled,	Bevel Down
4734BU	AK-4744BU	5.7 MM IMPLANT Angled,	Bevel Up
4735	AK-4745	5.7 MM IMPLANT Straight	
4738	AK-4748	6.2 MM IMPLANT Angled,	Bevel Down
4738BU	AK-4748BU	6.2 MM IMPLANT Angled,	Bevel Up
4739	AK-4749	6.2 MM IMPLANT Straight	
4766	AK-4776	6.7 MM IMPLANT Angled,	Bevel Up
4767	AK-4777	6.7 MM IMPLANT Straight	
	AK-5598	7.2 MM IMPLANT Angled,	Bevel Up
	AK-5599	7.2 MM IMPLANT Straight	

SPECIALITY KNIVES

A VARIETY OF SPECIALIZED BLADES FOR OPHTHALMIC AND OTHER MICROSURGICAL TECHNIQUES

	SCREW-IN BLADE	FULL HANDLE KNIFE	DESCRIPTION
	5435	AK-5485	P.D.I. .35 MM Depth
	5440	AK-5486	P.D.I. .40 MM Depth
	5450	AK-5490	P.D.I. .50 MM Depth
	5460	AK-5491	P.D.I. .60 MM Depth

SCLERAL BLADES AND KNIVES DESIGNED FOR TRABECULECTOMY AND GROOVE TYPE INCISIONS

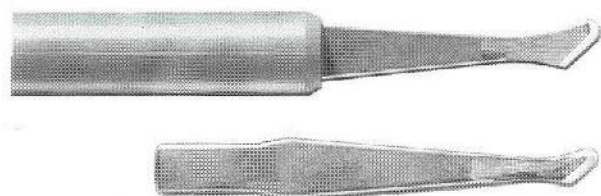
	5700	AK-5710	SCLERAL Standard USA Size
	5700S	AK-5710S	SCLERAL Small European Style

M.V.R. BLADES AND KNIVES DESIGNED FOR PRECISE VITRECTOMY INCISIONS

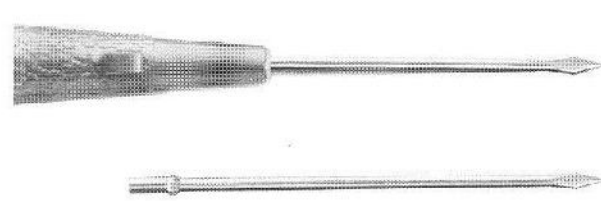
	5559*	AK-5561	MVR 19 GAGE
	5558*	AK-5560	MVR 20 GAGE
		AK-5565	MVR 20 GAGE Angled
		AK-5562	MVR 23 GAGE
		AK-5567	MVR 23 GAGE Angled

*Blade only-Use 1318 Handle

NEEDLE BLADES AND KNIVES DESIGNED FOR PEDIATRIC SURGERY AND PARACENTESIS TYPE INCISIONS

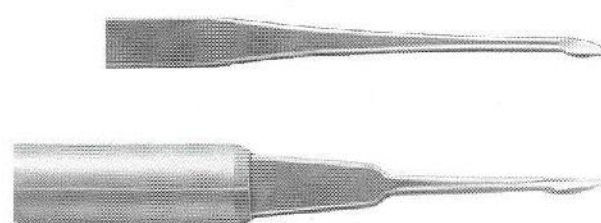
	5910		NEEDLE 3.0 MM Edge
	5920		NEEDLE 5.0 MM Edge
	5930		NEEDLE 7.0 MM Edge
	5940		NEEDLE 1.5 MM Edge
		AK-6805	NEEDLE European Style

disposable blades



disposable blades

SPECIALITY KNIVES

SCREW-IN BLADE	FULL HANDLE KNIFE	DESCRIPTION
----------------	-------------------	-------------

LAMELLAR BLADES AND KNIVES DESIGNED FOR FLAP AND TUNNEL INCISIONS

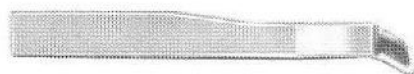

6600		LAMELLAR Angled, Bevel Up
6610		LAMELLAR Straight
5501	AK-5501H	LAMELLAR Straight
5502	AK-5502H	LAMELLAR Angled, Bevel Up
5503	AK-5503H	LAMELLAR Angled, Bevel Down

KERATOME BLADES DESIGNED FOR A VARIETY OF OPHTHALMIC INCISIONS



5500		KERATOME 2.3 MM Angled
5610		KERATOME Small 6 MM Angled
5620		KERATOME Medium 8 MM Angled
5630		KERATOME Large 12 MM Angled

CATARACT BLADES DESIGNED FOR A VARIETY OF OPHTHALMIC INCISIONS



5100		CATARACT Standard 19 MM
5210		CATARACT Small 20 MM
5220		CATARACT Medium 22 MM
5230		CATARACT Large 29 MM

Eye Spears / sponges

PVC, plastic handles

AK-4095 (10 Pcs / ponch180 Pcs / Box)



Eye Spears / sponges

cellulose, plastic handles

AK-4085 (10 Pcs / ponch180 Pcs / Box)

CHUCK HANDLE

For Use With all
Khosla Flat round
Stock Blades Won- Sterile

- K-3651/2** 2"
- K-3651/3** 3"
- K-3651/4** 4"
- K-3651/6** 6"
- K-3651/4H** 4"



BARD- PARKER

Handle

- K-3650/3** 3"
- K-3650/4** 4"
- K-3650/7** 7"

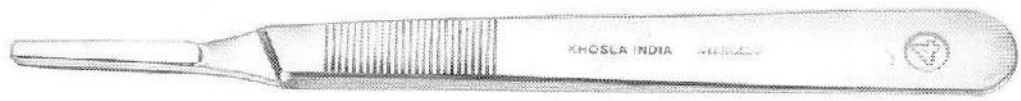
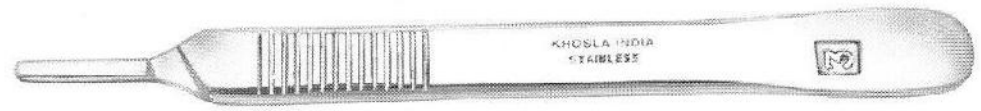

BARD PARKER

- K-3655/1** # 10
- K-3655/2** # 11
- K-3655/3** # 15





microscope

OPERATING MICROSCOPE K-6001

SPECIFICATIONS

Main Microscope	: NIKON STEREOZOOM OPTICAL HEAD
Eye pieces	: 10x
Inclination to vertical	: 45°
Interpupillary distance	: Adjustable from 52mm ~ 75mm
Working distance	: 181mm
Zooming range	: 0.8 ~ 3.5x
Fine Focusing	: Rack and pinion, 50mm manual adjust motorised foot control OPTIONAL at extra cost
Total magnification	: 4 ~ 17.5x Continuous without steps
Field of view	: 52mm ~ 12mm
Arms	: Counterbalanced Spring Arms
Horizontal length of arms	: 850 mm
Vertical height adjustment	: Maximum 1465mm Minimum 905mm
Rotation of arms	: 320° with Lock
Floor stand dimensions of base	: Mobile floor stand. (Table mount model OPTIONAL) : Length 520mm, Breadth 520mm Four caster wheels for easy handling ensures absolute stability
Coaxial illumination light source	: Cold Light 15V 150W Halogen Lamp Twinbulb-optical fibrelight guide system
Brightness	: Variable
Power supply	: AC 220-240 Volts or 110V on Request
Weight	: 48 Kgs.

Standard Accessories :

Dust Cover, Head Cover,
Autoclaving Caps.

Optional Accessories :

Motored Foot Control for
Fine Magnification.



SLIT LAMP K-6002

SPECIFICATIONS

Binocular Microscope

Eyeieces	: 10x (15x OPTIONAL)
Objectives	: 1x & 1.6x
Total magnification	: 10 x & 16 x (15 x & 24 x with 15 x magnification)
I.P.D. Adjustment	: 52 mm to 90 mm

Illumination Unit

Slit Image Rotation	: 0° to 180°
Tilting Illumination	: 5°, 10°, 15°, 20°
Filter Disc	: A Cobalt blue & a Green filter
Slit Diaphragm Disc	: 12, 10, 6, 4, 3, 1 and 0.2mm a wedge-shaped diaphragm for infinitely variable slit lengths

Up and down control	: Co-axial with joystick control
Lamp pre-focused	: 12V 50W, Quartz Halogen Lamp
Power supply	: AC 220-240 Volts or 110V on Request

- Applanation Tonometer can be mounted on the instrument.
- Net weight 25kgs.

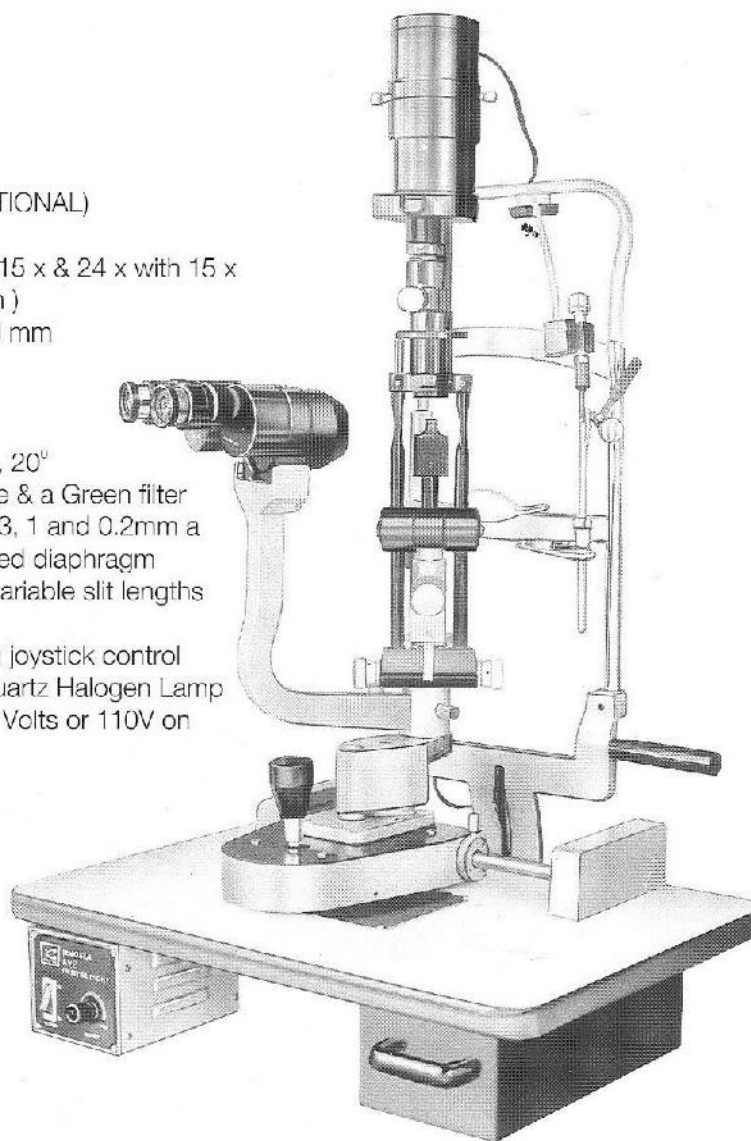

Standard Accessories : Hruby lens, 1 pair 15 x Eye piece, Reflecting lens, Dust Cover, 1 Halogen Bulb, Testing Rod.

Optional Accessories

- Manually operated Tripod Stand
- Motorised Stand
- Applanation Tonometer
- 3 Mirror Gonioscope lens

**KERATOMETER
K-6003**

FEATURES

- Coincides focusing system. Positive measurements to .02 mm accuracy.
- 15 x Wide-angle piece.
- One position instrument. Measures both meridians without changing optical system.
- Simple vertical adjustment to fit patient.
- Two-way adjustable head and chin rests.
- Dual eye-level sighting system. Facilitates horizontal alignment.
- Positive fixation. Permits rapid measurement of central corneal area.
- Precision objectives, Assures durability, Achromatic Lenses.
- Measuring range : Radius of curvature, 9.4 ~ 6.4mm* (in 0.05 mm steps)
- Diopter 36 ~ 52 (in 0.25 steps)

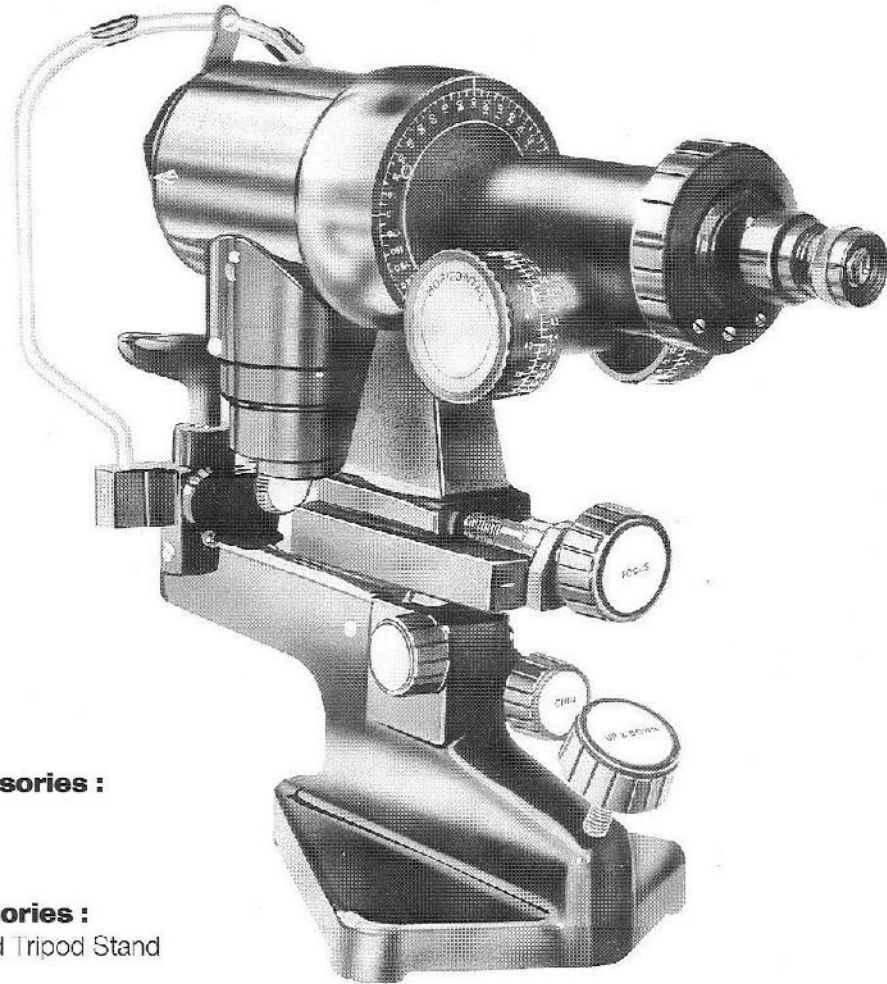

Standard Accessories :

- Dust Cover
- Spare Bulb

Optional accessories :

- Manually operated Tripod Stand
- Motorised Stand

LENSOMETER K-6004

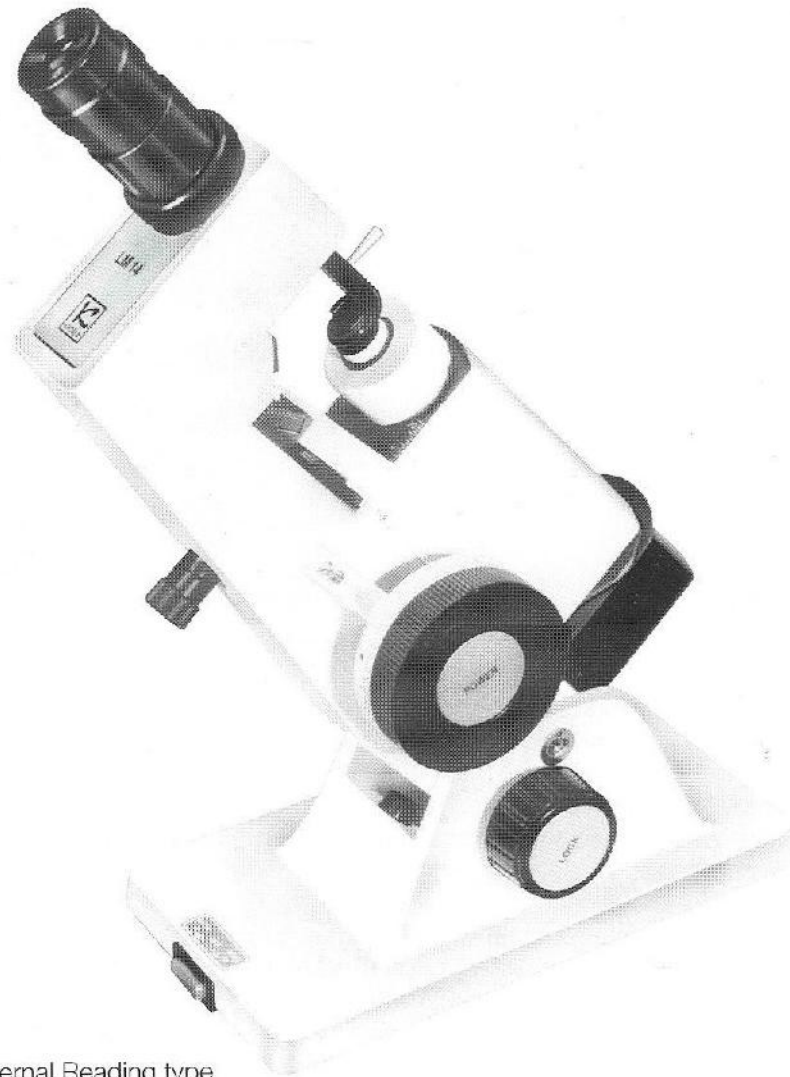

Specifications

Type	: External Reading type
Target	: Corona and cross, Rotable 360°
Vertex power range	: 0 to -10 Diopters (0.25 Diopter step) + 10 to 25 Diopters (0.50 Diopter step)
Cylindrical axis	: 0° to 180° (5° step)
Prismatic power	: 0 to 5 (1 step)
Acceptable Lens Diameter	: 20 to 80 mm
Titilable angle	: Continuously variable from 30° to 90°
Eyepiece focusing range	: 0 to 5 Diopters
Accuracy	: Accurate centering and marking of lenses.
Power requirement	: AC 220 240 Volts or 110V on Request.
Weight	: 4.5 kgs Approximately
Standard Accessorios	: Contact lens holder, Two spare bulbs, Dust cover.

**IRRIGATION / ASPIRATION (Electric)
K-6005**

Standard Accessories :

2 pcs I/A Probes With Tubing,
1 Plastic Bottle, 1 Pc Foot Control

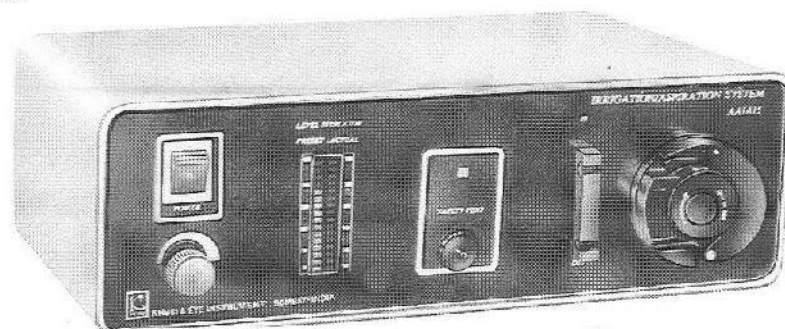

**VITRECTOMY (Electric)
K-6006**

For Anterior and Posterior segment
surgeries
Vitrectomy - Lensectomy + Irrigation/
Aspiration system for Extra Capsular
Cataract Extraction

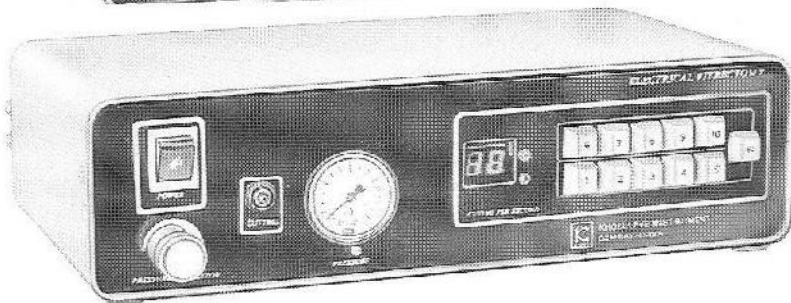

FEATURES

- Light weight, powerful vitreous cutter working with N2O or CO2 to provide powerful cutting action never achieved before.
- Interchangeable, Limited use of disposable blades (cutting edges) to guarantee perfect sharpness.
- Easy to read LED display for cutter speed-variable from single cut to 600 cuts per minute Electronically controlled.
- Guillotine cutting movement. Cutting port remains in open position when off - minimises tissue trauma.
- Vacuum can be preset anywhere from 0-500 mmHg available in **LINER OR FIXED** mode to match your individual needs.
- LED indicator for preset and actual vacuum.
- Single or multiport systems for uni or bimanual techniques.
- Independent and concurrent cutting, suction reflux possible.
- Versatile modular design customized to your needs.
- Light source, fluid-gas exchange, bipolar cautery can be added separately.
- You can safely and positively use all imported pneumatically driven handpieces presently available made by other manufacturers.
- Unique positive shut off valves for instant venting to atmosphere.
- Power supply : AC 220-240 Volts or 110V on Request.

Standard Accessories : 2 pcs connectors from cylinder to Unit 1 regulator for, 1 packet of washers, 2 power cards, 1 Foot Contract.

Optional Accessories : Vitreous cutters, Posterior Segment Surgery Set, Air Injector, Cold light Source with Endo Illuminator, Bipolar Co-agulator (K-6016), Endo Cryo Unit with intravitreal end freezing Probe (K-6011).

VITRECTOMY SUPER (Gas Operated) K-6007



VITRECTOMY SUPER

For Anterior and Posterior segment surgeries
 Vitrectomy - Lensectomy + Irrigation / Aspiration system for Extra Capsular Cataract Extraction

SPECIAL FEATURES

Non-electric, Portable, Foot controlled

No Compressor. No Vacuum Pump. No Battery

Unit works with cylinder of carbon-dioxide or Nitrous oxide or Central supply CO₂ or N₂O or mini air compressor to provide powerful cutting action

Single or multiport systems for Uni or Bimanual techniques

Provides variable cutting speed

Vacuum can be preset anywhere from 0-400 mm Hg available in linear or fixed mode to match your individual needs

Surgeon can have a selection of cutting and suction or cutting or suction alone

Lightweight autoclavable handpieces with single use disposable cutting edges unique system for the first time to guarantee perfect sharpness

Guillotine cutting movement. Cutting port remains in open position when off- minimises tissue trauma

You can safely and positively use all pneumatically driven handpieces presently available made by other manufacturers.

Unique positive shut off valves for instant venting to atmosphere totally eliminates reflux mechanism

Standard Accessories : 2 pcs connectors from Cylinder to Unit, 1 regulator,
 1 packet of washers, 1 foot control.

Optional Accessories : Vitreous cutters, Posterior Segment Surgery Set, Air Injector Cold Light source with Endo Illuminator, Bipolar Co-agulator (K-6016), Endo Cryo Unit with intravitreal end freezing probe (K-6011)

**SUPER DELUXE (Gas Operated)
Cryo & I/A System
K-6008**

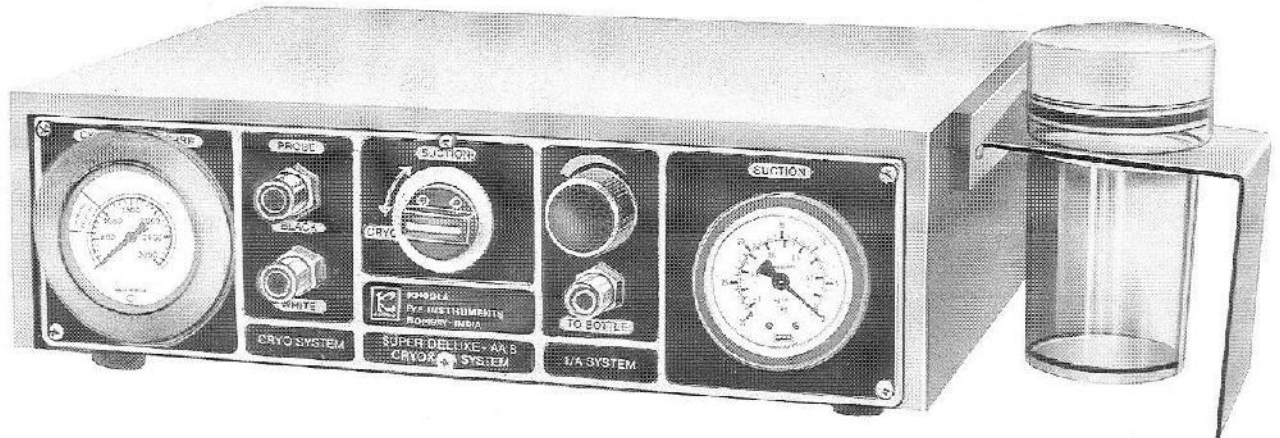

SPECIAL FEATURES

Completely Non-electric, Portable

Works with carbon-dioxide or nitrous oxide gas

Foot controlled

Quick Freezing

Instant defrosting by reversible flow of gas system - cleans the probes for every cycle automatically

Lightweight probe tips have high conductivity silver

Useful for Cataract, Retinal Detachment, Glaucoma and Intravitreal surgery

Single Footswitch for Cryo or I/A. Surgeon can select either of the two by a simple selector switch

Surgeon can have a selection of Irrigation or Irrigation and Aspiration with the two position footswitch

Suction variable from 0 - 300 mm Hg. Surgeon can preset the required vacuum

Lightweight, autoclavable I/A Handpieces available with 0.3 mm and 0.5 mm aspiration ports.

Standard Accessories : 1 Cataract probe, 1 Retinal probe,
2 pcs I/A Probe with Tubing.

Optional Accessories : Different type of Cryo probes (Ref page 135 for details)

**CRYO SUPER AA1
K-6010**

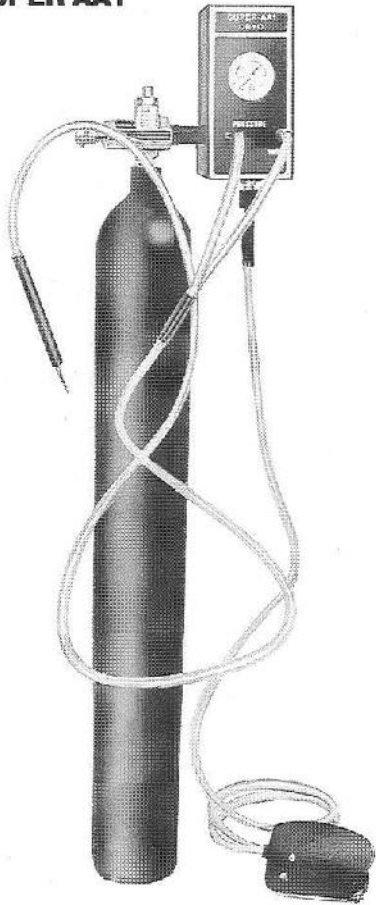

**CRYO SUPER AA2
K-6009**

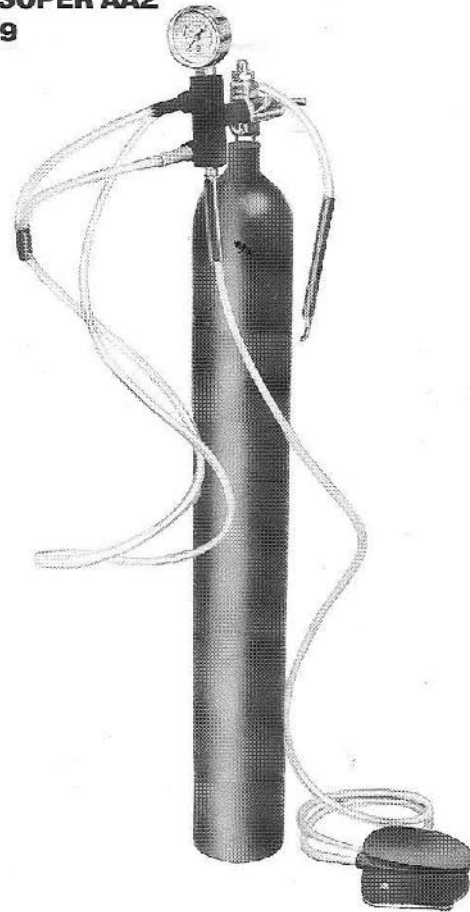

SPECIAL FEATURES

- Completely Non-electric, Portable
- Works with carbon-dioxide gas or nitrous oxide gas
- Foot controlled
- Quick Freezing and Quick defrosting
- Lightweight probe tips have high conductivity silver
- Useful for Cataract, Retinal Detachment, Glaucoma and Intravitreal surgery

Standard Accessories : 1 Cataract probe, 1 Retinal probe.

Optional Accessories : Different type of Cryo probes (Ref page 135 for details)

**CRYO SUPER DELUXE AA3
K-6011**

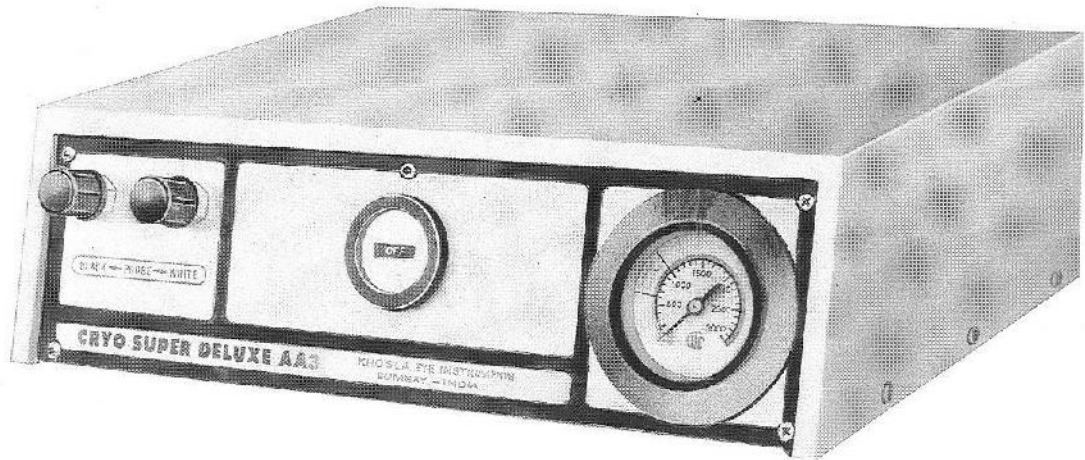

SPECIAL FEATURES

- Completely Non-electric, Portable
- Works with carbon-dioxide gas or nitrous oxide gas
- Foot controlled
- Quick Freezing
- Instant defrosting by reversible flow of gas system - cleans the probes for every cycle automatically
- Lightweight probe tips have high conductivity silver
- Useful for Cataract, Retinal Detachment, Glaucoma and Intravitreal surgery

Standard Accessories : 1 Cataract probe, 1 Retinal probe.

Optional Accessories : Different type of Cryo probes (Ref page 135 for details)

CRYO PROBES

K-6012 / C

Cataract Curved 1.4mm
Tip Temperature - 40° C

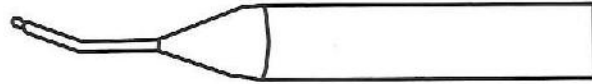

K-6012 / S

Cataract Straight 1.4mm
Tip Temperature - 40° C



K-6013 / C

Retina Curved 2.5mm
Tip Temperature - 80° C

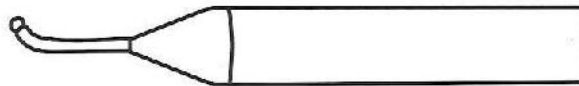

K-6013 / S

Retina Straight 2.5mm
Tip Temperature - 80° C



K-6014

Glaucoma Curved 3.5mm
Tip Temperature - 80° C



K-6015

Intra-Vitreous - 1.0mm
Tip Temperature - 20° C



**MICRO SURGICAL
(WET-FIELD CAUTERY)
K-6016**

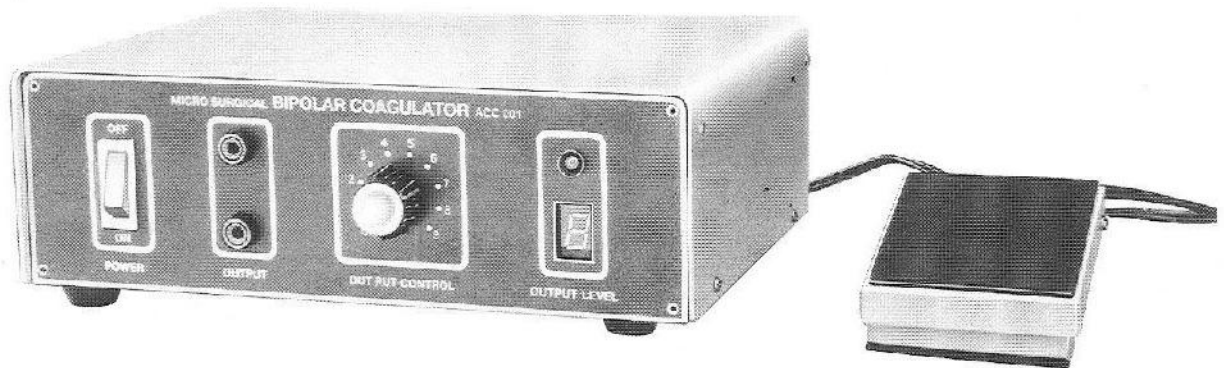

FEATURES

- Solid state circuitry
- LED indicator for power output
- Disposable/Autoclavable cords for use of forceps, erasers.
- Footswitch operated
- A wide selection of Bipolar forceps and Hemostatic erasers to facilitate most ophthalmic surgical procedures.
- Power supply AC 220-240 Volts or 110 V on request

Standard Accessory :

Bipolar Coagulator (wet-field cautery) supplied with one wet-field standard forceps.

Optional Accessories at extra cost :

- Wet field Mc pherson Irrigating forceps
- Wet-field Adson forceps for DCR/facial plastic surgery
- Wet-field Tenzal forceps
- Wet-field Bimanual Adapter
- Wet-field Hemostatic crasers for Anterior chambers 7 Retinal bleeders.
- Disposable / Autoclavable cords for use of forceps erasers.

SUGGESTED SURGERY SETS

	Page NO.
1. BASIC EYE SET	138
2. INTRA-CAPSULAR CATARACT EXTRACTION WITH IOL IMPLANTATION	139
3. EXTRA-CAPSULAR CATARACT EXTRACTION WITH IOL IMPLANTATION	139
4. EXTRA-CAPSULAR CATARACT EXTRACTION PHACOEMULSIFICATION	140
5. ASTIGMATIC SURGERY	141
6. RADIAL KERATOTOMY	142
7. CORNEAL TRANSPLANT	142
8. ENUCLEATION	143
9. GLAUCOMA SURGERY	143
10. LACRIMAL SURGERY DACRYOCYSTORHINOSTOMY & INTUBATION	143
11. LID SURGERY	144
12. MUSCLE SUREGY	145
13. VITREO-RETINAL SURGERY	145



basic eye set

BASIC EYE SET

K-1008	Lancaster Eye Speculum	K-2517/A	Bishop-Harmon Forceps 1X2 .3mm Teeth
K-1020/1	Barraquer Wire Speculum 8mm Blades	K-2532	McCullough Utility Forceps Ser- rated
K-1020/4	Barraquer Wire Speculum 14mm Blades	K-2546	Elschnig Fixation Forceps
K-1101/0	Desmarres Lid Retractor Infant 7.5mm	K-2552/1	Lester Fixation Forces 1 X 2 Teeth
K-1101/1	Desmarres Lid Retractor Small 11mm	K-2563/B	Castroviejo Suture Forcesps 1X2 .5mm Angled Teeth
K-1101/3	Desmarres Lid Retractor Infant 15mm	K-2564	Castroviejo Suture Forcesps 1X2 .12mm Teeth
K-1111	Schocket Scleral Depressor Double Ended	K-2600	Barraquer Colibri Forceps With- out Platform
K-1620/2	Jameson Muscle Hook Large	K-2616/4	Jewelers Forceps #4
K-1625	Green Muscle Hook	K-2618	McPherson Tyeing Forceps
K-1627	Stevens Tenotomy Hook	K-2626	Straight Smooth Jaw
K-1645	May retinal Detachment Hook With Oval Hole	K-2900/L	Kolman-McPherson Forceps 8mm Angled Jaw Smooth
K-1655/L	Twist Hook For Scleral Fixation Left	K-2900/R	Jameson Muscle Froceps 6 Teeth Left
K-1655/R	Twist Hook For Scleral Fixation Right	K-3001	Jameson Muscle Froceps 6 Teeth Right
K-1715	Arruga Retrator	K-3005	Iris Scissors 3.5" Curved
K-1752	Khosla Hand Cautery Battery Operated	K-3028	Iris Scissors 4.5" Straight
K-1815	Wills Hopital Cautery, Delicate Copper Ball	K-3037/B	Stevens Tenotomy Scissors Long Model Curved
K-2000	Khosla Flexible Rule, Stainless Steel	K-3100	De Wecker Iris Scissors Sharp & Blunt Tips
K-2003/S	Castroviejo Caliper Straight 20mm	K-3130/B	Westcott Tenotomy Scissors Blunt Tips
K-2101/C	Halsted Mosquito Forceps 5.5" Curved	K-3216	McPherson-Westcott Stitch Scissors Pointed Tips
K-2103/S	Serrefine 1.5" Straight	K-3223	Castroviejo Needle Holder, Stan- dard Jaws Straight With Lock
K-2106	Jones Towel Clamp	K-3227/CA	Castroviejo Blade Breaker & Holder
K-2205/B	Air Injection Cannula 27G.	K-3227/CB	Carbon Steel Blade Double Edged
K-2205/C	Air Injection Cannula 30G.	K-3650/3	Barraquer needle Holder, Very Delicate Jaws Curved Without MLock
K-2219	Bishop-Harmon Anterior Cham- ber Irrigator		Barraquer needle Holder, Very Delicate Jaws Curved With Lock
K-2500	Eye Dressing Forceps Serrated Straight		Bard Parker Handle #3
K-2513	Iris Forceps Serrated Curved		

K-3655/2 Bard Parker Handle #11
K-6100 Schiøtz Tonometer Certified
 Calibration
 Diamond Knife

INTRA - CAPSULAR CATARACT EXTRACTION With IOL IMPLANTATION

K-1020/3 Barraquer Eye Speculum 12mm
 Blades
K-1115 Rosenbaum-Drews Iris Retractor
 Left & Right
K-1622/2 Graefe Muscle Hook Medium
K-1656/S Kuglen Iris Hook And Lens Mani-
 pulator Clover Leaf Tip Straight
K-1661 Lester Lens Manipulator, Mod
 ified Vaulted Shank
K-1722/A Castroviejo Synechiae Spatula
 Double End Semi-Sharp .5 Width
K-1733/2 Lewis Lens Loop Large
K-2003/S Castroviejo Caliper 20mm
 Straight
K-2004 Stahl Caliper 7mm TO 13mm
K-2101/S Halsted Mosquito Forceps 5.50"
 Straight
K-2103/S Serrefine 1.50" Straight
K-2106 Jones Towel Clamp
K-2205/B Air Injection Cannula 27G
K-2205/C Air Injection Cannula 30G
K-2211/S Welsh Flat Olive Tip Cannula
 Straight
K-2219 Bishop-Harmon Anterior Cham-
 ber Irrigator
K-2500 Khosla Eye Dressing Forceps
 Serrated Straight
K-2546 Elsching Fixation Forceps
K-2552 Lester Fixation Forceps
K-2564 Castroviejo Suture Forceps 1X2
 0.12mm Teeth
K-2600 Barraquer Colibri Forceps
 0.12mm W/O Platform
K-2618 Mcpherson Forceps, Straight,
 Smooth Jaws

K-2620 Mcpherson Tying Forceps,
 Angled, Smooth Jaws
K-2626 Kelman-mcpherson Forceps,
 8mm Angled Jaws Smooth
K-2640 Shepard IOL Forceps, Oval W/
 O Lock
K-2804 Arruga Capsular Forceps
K-3040 Barraquer Iris Scissors 7mm
 Blades
K-3100 Westcott Tenotomy Scissors
 Medium Blade Blunt Tips
K-3118 Castroviejo Corneal Section
 Scissors Right
K-3119 Castroviejo Corneal Section
 Scissors Left
K-3128 Jaffe Stitch Scissors Medium
 Blades, Sharp Tips
K-3210/A Castroviejo needle Holder Deli-
 cate Jaws Straight W/Lock
K-3217 Castroviejo Blade breaker &
 Holder Slim Model
K-3223 Carbon Steel Double Edged
 Blade
K-3227/CA Barraquer Needle Holder Very
 Delicate Smooth Jaws Curved
 With Lock
AK-5700 Scleral Blade
K-3651/4 Chuck Handle Round 3"
KT-5103 Maloney Intra-Operative
 Keratometer
AK-4085 Eye Spears Cellulose
 (180Pcs/Box)
K-4002 Large Sterilizing Case With Four
 Silicone Mats

EXTRA-CAPSULAR CATARACT EXTRACTION WITH IOL IMPLANTATION

K-1020/3 Barraquer Eye Speculum 12mm
 Blades
K-1633 Sinsky Lens Manipulator
 Angled
K-1635 Gills-Welsh Lens Loop & Probe

K-1656/S	kuglen Irish Hook And Lens Manipulator Clover Leaf Tips St.	K-2626	Kelman-Mcpherson Forceps 8mm Angled Jaws Smooth
K-1722	Castroviejo Cyclodialysis Spatula 15mm	K-2634	Clayman Lens Holding Forceps
K-1740	Kansas Lens Loop 3mm Wide	K-2810	Kansas Nucleus Fragment Removing Forceps
K-1741	Kansas Nucleus Trisector	K-2826	Ultrala Capsulorhexis Forceps Flat Handle
K-1742	Kansas Nucleus Bisector	K-3040	Barraquer Iris Scissors 7mm Blades
K-1743	Kansas Nucleus Vectis Soild	K-3049	Gills-Welsh Vannas Scissors With 11mm Blade Angled On Flat
K-2003/S	Castroviejo Caliper 20mm Straight	K-3100	Westcott Tenotomy Scissors Medium Blades Blunt 1ip
K-2100/S	Hartmann Mosquito Forceps 3.25" Straight	K-3101	Westcott Tenotomy Scissors Standard Blades Pointed Tips
K-2103/S	Serrefine 1.50: Straight	K-3124	Troutman-Castroviejo Micro Comeal Scissors RT.
K-1743	Kansas Nucleus Vectis Soild	K-3125	Troutman-Castroviejo Micro Comeal Scissors LT.
K-2003/S	Castroviejo Caliper 20mm Straight	K-3210/A	Castroviejo Needle Holder Delicate Jaws ST. W/Lock
K-2100/S	Hartmann Mosquito Forceps 3.25" Straight	K-3228/CA	Barraquer Needle Holder Extra Delicate Smooth Jaws CVD W/ Lock
K-2103/S	Serrefine 1.50: Straight	AK-7515	Extra Sharp Blade 15° 5.00mm Depth
K-2106	Jones Towel Clamp	K-3651/4	Chuck Handle Round 3"
K-2205/C	Air Injection Cannula Angled 30G	K-5074	Thornton Limbal Incision Ruler
K-2218	Simcoe Irrigation Aspiration Cannula 23G Regular	KT-5103	Maloney Extra-Operative Keratometer
K-2219	Bishop-Harmon Anterior Chamber Irrigator	AK-4085	Eye Spears Cellulose (180Pcs/Box)
K-2221/B	Viscoelastic Aspirating Cannula Angled 10mm, 22G.	K-4002	Large Sterilizing Case With Four Silicone Mats
K-2241	Jensen Posterior Capsule Polisher		
K-2256	Kelman Cystotome Straight Sharp 22G		
K-2517/A	Bishop-Harmon Iris Forceps 1X2 .5mm Teeth		
K-2535	Bonacollo Utility Forceps Delicate Model		
K-2555	Troutman Superior Rectus Forceps		
K-2562/A	Castroviejo Suture Forceps 0.12mm Regular Teeth		
K-2562/C	Castroviejo Suture Forceps Smooth Jaws		
K-2600	Barraquer Colibri Forceps 0.12 mm Teeth W/O Platform	K-1043/2	Kratz Barraquer Wire Speculum
K-2620	Mcpherson Tying Forceps, 5mm Angled Jaws Smooth	K-1664	Double Hook Nucleus Rotator & Iris Retractor

EXTRA - CAPSULAR CATARACT EXTRACTION PHACOEMULSIFICATION



astigmatic surgery

K-1644/2 Bechert Nucleus Rotator Angled 9mm
K-2003/S Castroviejo Caliper 20mm Straight
K-2100/S Hartmann Mosquito Forceps 3.25" Straight
K-2101/C Halsted Mosquito Forceps 5.50" Curved
K-2106 Jones Towel Clamp
K-2205/C Anterior Cannula 30G Angled
K-2217 Kratz Cystotome Angled 27G
K-2219 Bishop-Harmon Anterior Chamber Irrigator
K-2221/B Viscoelastic Aspirating Cannula Angled 10mm 22G
K-2290/L McIntyre Binkhorst Cortex Aspirating Cannula
K-2290/R McIntyre Binkhorst Cortex Aspirating Cannula
K-2241/2 Jensen Posterior Capsule Polisher 25G
K-2535 Bonaccolto Forceps Delicate
K-2563/B Castroviejo Suture Forceps 0.5mm Angled Teeth
K-2564 Castroviejo Suture Forceps 1 X 2 0.12mm Teeth
K-2600 Barraquer Colibri Forceps W/O Platform
K-2626 Kelman-Mcpherson Forceps, 8mm Angled Jaws Smooth
K-2627 Blaydes IOL Insertion Forceps
K-2646/C Tennant Tying Forceps, Curved
K-2646/S Tennant Tying Forceps, Straight
K-2680 Faulkner Lens-Holding Forceps
K-2681 Faulkner Lens-Folding Forceps
K-2826 Utrata Capsulorhexis Forceps Flat Handle
K-2839 Steinert Universal IOL Folding Forceps
K-2840 Fine Universal IOL Inserting Forceps
K-3049 Stern-Gills Capsulotomy Scissors 10mm Angled Forward
K-3100/A Westcott Tenotomy Scissors Medium Blades Blunt Tips

K-3210/A Castroviejo Needle Holder Delicate Jaws Straight W/Lock
K-3244/A Needle Holder Very Delicate Jaws Curved With Lock
AK-5520/BU Slit Blade, Angled
AK-4732/BU Incision Enlarging Blade 4.0mm
AK-5590/BU Incision Enlarging Blade 5.2mm
AK-7515 Sharp Blade 15°, 5.0mm Depth
K-3651/4 Chuck Handle Round 4"
KT-5103 Maloney Intra-Operative Keratometer
AK-4085 Eye Spears, Cellulose (180Pcs/Box)
K-4002 Large Sterilizing Case with Four Silicone Mats

ASTIGMATIC SURGERY

K-1021/3 Barraquer Wire Speculum Solid Blades Large 12mm Blades
K-2205/B Air Injection Cannula Angled 27G
K-2564 Castroviejo Suture Forceps 1 X 2 0.12mm Teeth
K-2811 Boros Incision Spreading Forceps
K-4002 Large Sterilizing Case With Four Silicone Mats
K-5000 Thornton Low Profile Globe Fixation Ring 7 Markings 16mm Inner Diameter
K-5001 Mendez Degree Gauge, 12mm Inner Diameter
K-5002 Bore Axis Marker, Used With Mendez Degree Gauge
K-5032 Dietz Incision Depth Gauge
K-5038 Hoffer Optic Zone Marker 7mm
K-5063/S Bore Corneal Fixation Forceps 3mm Spread Straight
K-5068/2 Grandon T-Incision Marker 3mm Wide
K-5074 Thornton Limbal Incision Ruler
AK-4085 Diamond Knife With MicroMeter
Greene Visual Axis Markers
Eye Spears Cellulose (180Pcs/Box)



radial keratotomy

K-4001 Two Silicone Mat
Size 26cm X 21cm

RADIAL KERATOTOMY

K-1021/3 Barraquer Wire Speculum Solid
Blades Large 12mm Blades

K-2205/B Air Injection Cannula Angled 27G

K-2811 Bore's Incision Spreading For-
ceps

K-4002 Large Sterilizing Case With Four
Silicone Mats

K-5000 Thorton Low Profile Globe Fixa-
tion Ring 8 Markings 16mm In-
ner Diameter

K-5032 Neumann Incision Depth Gauge

K-5034 Hoffer Optical Center Marker
With Cross Hairs, 3.0mm

K-5034 Hoffer Optical Center Marker
With Cross Hairs, 3.25mm

K-5035 Hoffer Optical Center Marker
With Cross Hairs, 3.5mm

K-5035 Hoffer Optical Center Marker
With Cross Hairs, 3.75mm

K-5036 Hoffer Optical Center Marker
With Cross Hairs, 4.00mm

K-5036 Hoffer Optical Center Marker
With Cross Hairs, 4.25mm

K-5037 Hoffer Optical Center Marker
With Cross Hairs, 4.5mm

K-5038 Hoffer Optical Center Marker
With Cross Hairs, 5.0mm

K-5050 Bore's Radial Marker 9.5mm O.D.

K-5060 Kansas Radial Marker 12.5mm
O.D.

K-5061/C Kremer Corneal Fixation Forceps
With Lock 13mm Spread Curved

K-5063/S Bore's Corneal Fixation Forceps
3mm Spread Straight
Diamond Knife With Micrometer
Greene Visual Axis Marker

AK-4085 Eye Spears Cellulose
(180Pcs/Box)

K-4001 Two Silicone Mat Size
26cm X 21cm

CORNEAL TRANSPLANT

K-1020/3 Barraquer Eye Speculum 12mm
Blades

K-1113 Flieringa Scleral Fixation Rings
Set Of 8 Sizes (15-22mm)

K-1732 Paton Spatula & Spoon

K-1903 Castroviejo Corneal Trepphine
Blade 7.5mm

K-1903 Castroviejo Corneal Trepphine
Blade 8mm

K-2100/S Hartmann Mosquito Forceps
3.25" Straight

K-2103/S Serrefine 1.50" Straight

K-2106 Jones Towel Clamp

K-2205/C Air Injection Cannula Angled 30G

K-2219 Bishop-Harmon Anterior Cham-
ber Irrigator

K-2221/B Viscoelastic Aspirating Cannula
Angled 10mm, 22G

K-2562/A Iris Forceps Bonn Model Very
Delicate

K-2563/A Castroviejo Suture Forceps 1X2
Angled .3mm Teeth

K-2563/B Castroviejo Suture Forceps 1X2
Angled .5mm Teeth

K-2600 Barraquer Colibri Forceps
0.12mm Teeth W/O Platform

K-2646/C Tennant Tying Forceps Curved

K-2646/S Tennant Tying Forceps Straight

K-2652 Polack Double Corneal Forceps
1mm Spread 0.12mm Teeth At
Each Tip

K-3048 Gills Vannas Capsulotomy Scis-
sors Very Delicate 11mm Blade

K-3124/A Troutman-Castroviejo Micro
Corneal Scissors With Stop Lock
RT.

K-3125/A Troutman-Castroviejo Micro
Corneal Scissors With Stop Lock
LT.

K-3128 Jaffe Stitch Scissors Medium
Blades Sharp Tips

K-3211/A Castroviejo Needle Holder Deli-
cate Jaws Curved W/Lock

- K-3228/CA** Barraquer Needle Holder Extra
Delicate Smooth Jaws Cvd W/
Lock
- KT-5103** Maloney Intra-Operative
Keralometer
- K-4085** Eye Spears Cellulose
(180Pcs/Box)
- K-4002** Large Sterilizing Case With Four
Silicone Mats

ENUCLEATION

- K-1008** Lancaster Eye Speculum
- K-1622/2** Graefe Musclic Hook Medium
- K-2101/C** Halsted Mosquito Forceps 5.50"
- K-2503** Iris Forceps 1X2 Teeth Straight
- K-3026** Stevens Tenotomy Scissors
Long Model
- K-3032** Enucleation Scissors Full Curved
- K-4002** Large Sterilizing Case With Four
Silicone Mats

GLAUCOMA SURGERY

- K-1020/3** Barraquer Eye Speculum 21mm
Blades
- K-1722** Castroviejo Cyclodialysis
Spatula Double End 10mm &
15mm .5 Width
- K-2003/S** Castroviejo Caliper 20mm
Straight
- K-2100/S** Hartmann Mosquito Forceps
3.25" Straight
- K-2106** Jones Towel Clamp
- K-2205/B** Air Injection Cannula 27G
- K-2219** Bishop-Harmon Anterior Cham-
ber Irrigator
- K-2315/L** Harms Trabeculotomy Probe Left
- K-2315/R** Harms Trabeculotomy Probe
Right
- K-2414** Gass Corneoscleral Puch
- K-2500** Khosla Eye Dressing Forceps
Serrated Straight
- K-2517/B** Bishop-Harmon Iris Forceps 1X2
.5mm Teeth

- K-2564** Castroviejo Suture Forceps 1 X
2 0.12mm Teeth
- K-2600** Barraquer Colibri Forceps W/O
Platform
- K-2618** Mcpherson Typing Forceps,
Smooth Jaws Straight
- K-2620** Mcpherson Typing Forceps,
Smooth Jaws Angled
- K-3009** Eye Scissors 5" Pointed Straight
- K-3040** Barraquer Iris Scissors 7mm
Blades
- K-3042** Vannas Capsulotomy Very Deli-
cate 6mm Blade Straight
- K-3100/A** Westcott Tenotomy Scissors
Medium Blades Blunt Tips
- K-3130/B** Mcpherson-Westcott Stitch
Scissors, Small Blades Pointed
Tips
- K-3210/A** Castroviejo Needle Holder Deli-
cate Jaws Straight W/Lock
- K-3227/CA** Barraquer Needle Holder Very
Delicate Smooth Jaws Curved
With Lock
- AK-5700** Scleral Blade
- AK-7515** Extra Sharp Blade 15° 5.0mm
Depth
- K-3651/4** Chuck Handle Round 3"
- K-6100** Shiolz Tonometer
Diamond Knife
Sclerotome Blade
Super Sharp Blade
- AK-4085** Eye Spears/Sponges Cellulose
- K-4002** Large Sterilizing Case With Four
Silicone Mats

LACRIMAL SURGERY DACRYOCYSTORHINOSTOMY & INTUBATION

- K-1039** Stevenson Lacrimal Sac Retrac-
tor Serrated Solid Blades
- K-1055/3** Khosla Nasal Speculum Adult
- K-1654/2** Knapp Lacrimal Sac Retractor
- K-2101/C** Halsted Mosquito Forceps 5.50"
- K-2101/S** Halsted Mosquito Forceps 5.50"



K-2105/2	Backhaus Towel Clamp 5.25"	K-1101/2	Desmarres Lid Retractor Small 13mm
K-2203/C	Lacrimal Cannula Curved 23G	K-1101/3	Desmarres Lid Retractor Medium 15mm
K-2203/S	Lacrimal Cannula Straight 23G	K-1104	Jaeger Spatula All Metal
K-2219	Bishop-Harmon Anterior Chamber Irrigator	K-1602/1	Guthrie Fixation Hook, Small
K-2300	Bowman Lacrimal Probe Cylindrical Set Of 4 Sizes	K-1622/1	Graefe Muscle Hook, Small
K-2306/A	Pigtail Probe With Suture Holes	K-1622/2	Graefe Muscle Hook, Medium
K-2309	Castroviejo Lacrimal Dilator, Double End Fine & Medium Taper,	K-1805/1	Meyhoefer Chalazion Curette 1.75mm
K-2401	Beyer Bone Rongeur	K-1805/2	Meyhoefer Chalazion Curette 2.25mm
K-2402/3	Kerrison Bone Rongeur Large	K-1805/3	Meyhoefer Chalazion Curette 2.50mm
K-2404	West Bone Chisel For Lacrimal Sac	K-1805/4	Meyhoefer Chalazion Curette 3.50mm
K-2407	Freer Periosteal Elevator	K-2003/S	Castroviejo Caliper 20mm Straight
K-2408	Freer Bone Chisel For Lacrimal Sac	K-2100/C	Hartmann Mosquito Forceps 3.25"mm Curved
K-2409/1	Crawford lacrimal Intubation Set	K-2100/S	Hartmann Mosquito Forceps 3.25"mm Straight
K-2410/2	Crawford Retrieving Hook	K-2106	Jones Towel Clamp
K-2412	Hammer For D.C.R.	K-2219	Bishop-Harmon Anterior Chamber Irrigator
K-2500	Khosla Eye Dressing Forceps Serrated Straight	K-2517/B	Bishop-harmon Iris Forceps 1X2 .5mm Teeth
K-2535	Bonaccolto Utility Forceps Delicate Model	K-2538	Graefe Fixation Forceps Without Catch
K-2563/B	Castroviejo Suture Forceps 1X2 Angled .5mm Teeth	K-2562/B	Castroviejo Suture Forceps 1 X 2 Regular .3mm Teeth
K-2611	Sauer Fixation Forceps 1X2 Teeth	K-2625	Kelman-McPherson Forceps, 1X2 Teeth 8mm Angled
K-3003	Iris Scissors 4 1/8" Straight Blunt	K-2642/C	Harms-Jaffe Tying Forceps, Curved
K-3028	Stevenson Tenotomy Scissors Long Model Cvd	K-2661	Maumenee Corneal Colibri Forceps 1X2 0.12mm Teeth
K-3130/B	McPherson Westcott Stitch Scissors Pointed	K-2916	Berke Ptosis Clamp 20mm
K-3210/B	Castroviejo Needle Holder W/O Lock Delicate Jaws	K-2923/1	Desmarres Chalazion Forceps 20mm
AK-6500	Miniature Blade	K-2926	Erhardt Lid Forceps
K-3651/4	Chuck Handle Round 3"	K-2927	Hunt Chalazion Forceps
K-4002	Large Sterilizing Case With Four Silicone Mats	K-3009	Eye Scissors 5" Pointed Straight
LID SURGERY		K-3026	Stevens Tenotomy Scissors Long Model Straight, Blunt
K-1101/1	Desmarres Lid Retractor Child 11mm		

K-3100/A Westcott Tenotomy Scissors,
Medium Blades Blunt Tips.
K-3101 Westcott Tenotomy Scissors
Standard Blades Pointed Tips.
K-3202 KALT Needle Holder Straight
K-3211/A Castroviejo Needle Holder Deli-
cate Jaws Curved With Lock
AK-6900 Miniature Blade, Round Tip,
Sharp all Around
K-3651/4 Chuck Handle Round 3"
AK-4085 Eye Spears, Cellulose
K-4002 Large Sterilizing Case With
Four Silicone Mats

MUSCLE SURGERY

K-1028 Park Eye Speculum
K-1101/1 Desmarres Lid Retractor Child
11mm
K-1101/2 Desmarres Lid Retractor Small
13mm
K-1620/1 Jameson Muscle Hook Small
K-1620/2 Jameson Muscle Hook Large
K-1622/1 Graefe Muscle Hook Small
K-1622/2 Graefe Muscle Hook Medium
K-1622/3 Graefe Muscle Hook Large
K-1627 Stevens Tenotomy Hook
K-2000 Khosla Flexible Rule
K-2003/S Castroviejo Caliper 20mm
Straight
K-2101/C Halsted Mosquito Forceps
5.50" Curved
K-2101/S Halsted Mosquito Forceps
5.50" Straight
K-2103/S Serrefine 1.50" Straight
K-2105/1 Backhaus Towel Clamp
Small 3.50"
K-2219 Bishop-Harmon Anterior
Chamber Irrigator
K-2500 Khosla Eye Dressing Forceps
Delicate Model
K-2517/B Bishop-Harmon Iris Forceps
1X2 .5mm Teeth
K-2535 Bonaccolto Utility Forceps

K-2535 Bonaccolto Utility Forceps
K-2562/B Castroviejo Suture Forceps
1X2 .3mm Teeth
K-2563/B Castroviejo Suture Forceps
1X2 .5mm Teeth
K-2642/C Jaffe Tying Forceps, Curved
K-2642/S Jaffe Tying Forceps, Straight
K-2900/L Jameson Muscle Forceps 6
Teeth LT
K-2900/R Jameson Muscle Forceps 6
Teeth RT
K-2902/L Sattler Muscle Forceps 4 Teeth
LT
K-2902/R Sattler Muscle Forceps 4
Teeth RT
K-3003 Iris Scissors 4 1/8" Straight
K-3026 Stevens Tenotomy Scissors
Straight
K-3028 Stevens Tenotomy Scissors
Curved
K-3100 Westcott Tenotomy Scissors
Blunt Tips
K-3101 Westcott Tenotomy Scissors
Pointed Tips
K-3210/A Castroviejo Needle Holder
Delicate Jaws Straight
W/Lock
K-3210/B Castroviejo Needle Holder
Delicate Jaws Straight
W/O Lock
AK-6900 Miniature Blade, Round Tip
Sharp All Around
K-3651/4 Chuck Handle Round
AK-4085 Eye Spears, Cellulose
K-4002 Large Sterilizing Case With
Four Silicone Mats

VITREO - RETINAL SURGERY

K-1004/2 Williams Eye Speculum Adult Size
K-1112/2 Schepens Scleral Depressor
With Thimble
K-1312 Stiletto Blade For Stab Incisions
K-1620/2 Jameson Muscle Hook Large



retinal surgery

- K-1645** May Retinal Detachment Hook
K-1717 Schepens Orbital Retractor
K-2003/S Castroviejo Caliper 20mm Straight
K-2100/S Hartmann Mosquito Forceps Straight 3.25"
K-2101/C Halsted Mosquito Forceps Curved 5.50"
K-2103/S Serrefine Straight 1.50"
K-2105/2 Backhaus Towel Clamp 5.25"
K-2106 Jones Towel Clamp
K-2530 Utility Forceps 4" Serrated Straight
K-2535 Bonaccolto Utility Forceps Delicate
K-2562/C Castroviejo Suture Forceps Smooth Jaws
K-2563/B Castroviejo Suture Forceps 1X2 Angled .5mm Teeth
K-2600 Barraquer Colibri Forceps W/O Platform
K-2611 Sauer Suture Forceps 1X2 Tooth
K-2683 Intraocular Forceps
K-2812 Watzke Sleeve Spreading Forceps
K-3009 Eye Scissors 5" Straight Pointed
K-3010 Eye Scissors 5" Curved Pointed
K-3026 Stevens Tenotomy Scissors Long Model ST, Blunt
K-3042 Vannas Capsulotomy Scissors Very Delicate 6mm Blade Straight
K-3100 Westcott Tenotomy Scissors Standard Blades
K-3136 Intraocular Scissors
K-3210/A Castroviejo Needle Holder Delicate Jaws Straight W/Lock
K-3211/A Castroviejo Needle Holder Delicate Jaws Curved With Lock
AK-6400 Miniature Blade, Round Tip, Sharp one Side
K-3651/4 Chuck Handle Round 3"
K-3140 Vitrectomy Scissors, Angled 80°
K-2686 Vitrectomy Forceps Serrated Jaws, straight
- K-2687** Vitrectomy Forceps, Smooth Jaws with Platform
AK-4085 Eye Spears, Cellulose
K-4002 Large Sterilizing Case With Four Silicone Mats

CARE OF MICRO SURGICAL INSTRUMENTS

1. MANUAL CLEANING

- i. Immediately rinse the instruments with distilled water after use to remove blood, saline, tissue And other deposits which will stain the instruments.
- ii. Always use a soft tooth brush with mild soap for cleaning.
- iii. Wash the instruments thoroughly with distilled and dry the instruments with a hot air blower or with a soft lint free cloth. (While using a cloth for drying be very careful as the tips can get damaged by contact)

2. ULTRASONIC CLEANING

- i. Ultrasonic cleaning is the best method of clearing micro surgical instruments. Regular Cleaning of the instruments with ultrasonic cleaner with increase the life of instruments.
- ii. Strictly follow the instruction of the manufacturer of your ultrasonic cleaner & use only the Recommended solution for cleaning.
- iii. Do not allow the instruments to touch one another in the ultrasonic cleaner.
- iv. Wash the instruments thoroughly with distilled water and dry the instruments with a hot air blower or with a soft lint free cloth. (While using a cloth for drying be very careful as the tips can get damaged by contact)

3. STERILIZATION

- i. Micro surgical instruments can be sterilized by the following methods
 - a. Autoclaving
 - b. Dry heat
 - c. Gas
 - d. Dry chemical
 - e. Boiling.
- ii. Whichever method of sterilization is used, strictly following the instructions of the manufacturer of the sterilizer
- iii. Clean your instruments thoroughly before sterilizing as sterilizing is not cleaning.
- iv. Instruments not required for surgery should not be sterilized, as sterilizing reduces the life of instruments.
- v. Regularly inspect the internal parts of your sterilizer for rust, as this rust can damage your Instruments while sterilizing.
- vi. Do not allow the instruments to touch one another in the sterilizer.
- vii. Do not allow the instruments to over heat, or be kept in the sterilizer for a long period of time, as this will damage the instruments.

4. INSPECTION

- i. Inspect your microsurgical instruments regularly under a microscope to check the working
- ii. Do not use damaged instruments for surgery.

5. LUBRICATION

- i. Regularly lubricate the joints & locks of the instruments with a high grade lubricant.

6. STORING

- i. Clean the instruments thoroughly before storing.
- ii. Store the instruments in a dry place.
- iii. Always protect the tips of the instruments with soft silicone tubing before storage.
- iv. Do not allow the instruments to move or touch one another when stored.
- v. Use trays with soft silicone mats for storing the instruments.
- vi. All delicate and costly instruments, such as diamond knife, ect. should be stored separately.

A

A.C. Wash Cannula K-2200	104
Adjustable Trial Frame K-3502	114
Adler Bone Rongeur K-2403	80
Air Injection Cannula K 2205	104
Aker Lens Pusher K-1647	39
Algerbrush Corneal Rust Ring Remover	
Battery Operated Complete K-1755	51
Anis Capsule Scrubber K-1823	50
Anis Irrigating Vectors K-2248	110
Ant Lens Loop Serrated K-1707	45
Arrow Smith Corneal Fixation Forceps K-5062	19
Arruga Capsular Forceps K-2804	78
Arruga Capsular Forceps New Curve K-2805	78
Arruga Needle Holder K-3200	99
Artificial Acrylic Eye K-3600	115
Atkinson Retrobulbar Needle K-2223	104
Atraumatic Phaco Fixation Ring K-5102	14
Atraumatic Phaco Fixation Ring K-5104	14
Axenfeld Lacrimal Sac Retractor K-1613	30
Axenfeld Chalazion Curette Double End K-1810	50
Ayer Chalazion Forceps K-2920, K2921	83

B

Baby Barraquer Needle Holder Delicate Jaws K-3240	101
Baby Barraquer Needle Holder Delicate Jaws K-3241	101
Backhaus Towel Clamp K-2105	62
Bard-Parker Blade K-3655	125
Bard-Parker Handle K-3650	125
Barraquer Cilia Forceps K-2703	77
Barraquer Colibri Forceps KT-2601	5
Barraquer Colibri Forceps K-2600	69
Barraquer Fixation Forceps K-2543	66
Barraquer Iris Scissors K 3040	93
Barraquer Iris Spatula K-1703	43
Barraquer Needle Holder Delicate Jaws K-3208	100
Barraquer Needle Holder Extra Delicate Jaws K-3228	100
Barraquer Needle Holder K-3205	99
Blaydes Iol Insertion Forceps KT 2627	10
Barraquer Needle Holder Standard Jaws K-3206	100
Blaydes Iol Insertion Forceps K-2627	82
Barraquer Wire Speculum K 1020	24
Barraquer Wire Speculum Solid Blades K-1021	24

Bechert Lens Holding Forceps K-2676	75
Barraquer Wire Speculum K-1020/R	26
Barraquer Needle Holder K-3206, K3207, K3209	100
Barraquer Needle Holder K-3227/SA, K3227/CB	100
Bechert Nucleus Rotator KT-1644	3
Bechert Nucleus Rotator K-1644	41
Bechert-Mc Pherson KT 2662	6
Bechert-Mc Pherson K-2662	73
Blaydes Iol Insertion Forceps KT-2627	7
Blaydes Iol Insertion Forceps K-2627	75
Bechert-McPherson Forceps K-2662	73
Beer Cilia Forceps K-2704	77
Borke Ptoisis Clamp K-2916	83
Beyer Bone Rongeur K-2401	59
Bimanual Irrigation Aspiration System	20
Bipolar Coagulator Unit (Electric Operated) K-6016	136
Bipolar Forceps	85
Bishop Harmon Anterior Chamber Irrigator K-2219	106
Bishop-Harmon Iris Forceps KT-2517	5
Bishop-Harmon Iris Forceps K 2517	64
Blade Breakers & Holders	103
Blaydes Iol Insertion Forceps K-2627	75
Bonaccollo Capsule Fragment Forceps K-2630	76
Bonaccollo Utility Forceps Delicate Model K-2535	65
Bonaccollo Utility Forceps Heavy Model K 2538	65
Bonn Forceps K-2523	71
Bonn Micro Iris Hook K-1639	37
Bonn Model Iris Scissors K-3033, K-3034	92
Bores Axis Marker K-5002	16
Bores Corneal Fixation Forceps K-5063	19
Bowman Lacrimal Probe K-2300	53
Bronson-Turtz Iris Retractor K-1118	32
Bunge Evisceration Spoon K-1808	49

C

Calipers	52
Cannulas	104-111
Carbon Steel Double Edged Blade K-3223	103
Castroviejo Acrylic Implants K-3601	115
Castroviejo Suture Forceps KI-2562	5
Castroviejo Suture Forceps K-2562	71
Castroviejo Suture Forceps K 2503	71
Castroviejo Suture Forceps KT-2564	5
Castroviejo Suture Forceps K-2563	71
Castroviejo Blade Breaker & Holder K-3216	103

Castroviejo Blade Breaker & Holder Slim Model K-3217	103
Castroviejo Capler K-2002	52
Castroviejo Capler K-2003	52
Castroviejo Colibri Forceps KT-2649	5
Castroviejo Colibri Forceps K-2649	69
Castroviejo Corneal Scissors, Angled K-3115	97
Castroviejo Corneal Scissors, Universal K-3103,3104	96
Castroviejo Corneal Scissors K-3116	97
Castroviejo Corneal Trophino K-1901	57
Castroviejo Cyclodialysis Cannula K-2201	104
Castroviejo Cyclodialysis Spatula K-1704	43
Castroviejo Eye Speculum K-1031	24
Castroviejo Lacrimal Dilator Double End, Fine & Medium Taper K-2309	54
Castroviejo Miniature Corneal Scissors, Angled K-3108	97
Castroviejo Miniature Corneal Scissors K-3105,K-3106,K-3107	98
Castroviejo Miniature Corneal Scissors K-3118	98
Castroviejo Needle Holder KT-3210	10
Castroviejo Needle Holder Delicate Jaws K-3210	101
Castroviejo Needle Holder Standard Jaws K-3212	101
Castroviejo Suture Forceps K-2562	71
Castroviejo Synnechia Spatula Double End K-1722/A	44
Castroviejo-Kalt Needle Holder K-3204	99
Castroviejo Cyclodialysis Spatula Double End K-1722	44
Cataract Probe For Cryo Unit K-6012	135
Cautery	50-51
Chuck Handle Round K-3651	125
Citelli Bone Rongeur K-2400	59
Clark Eye Speculum K-1006	22
Clayman Lens Holding Forceps K-2634	75
Clayman Nucleus Rotator K-1665	41
Cocotation Bipolar Forceps K-2931	85
Cohan Colibri Forceps K-2660	69
Colibri Bipolar Forceps K-2934	85
Cook Eye Speculum K-1049	23
Cosmetic Eye Shell K-3605	115
Crawford Lacrimal Intubation Set K-2409/1	56
Crawford Retrieving Hook K-2409/2	56
Critchett Eye Speculum K-1001	22
Cryo & I/A System (Gas Operated) K-6008	132
Cryo Unit (Gas Operated) K-6009	133
Cryo Unit Delux (Gas Operated) K-6010	133
Cryo Unit Super Delux (Gas Operated) K-6011	134
Culler Rectus Muscle Hook K-1626	36
Culler Rectus Muscle Hook K-1628	36
Curettes	50-51
Cystotome & Loop K-1455	47

D

Daljit Irrigation Aspiration Cannula K-2222	105
Dastoor Conjunctival Flap Forceps K-2560	68
Dastoor Lacrimal Sac Dissector Double End K-2310	54
Dastoor Pupil & Iris Restorator K-1723	44
Dastoor Superior Rectus Forceps K-2554	68
De-Weeker Iris Scissors K-3037	93
Desmarres Chalazion Forceps K-2923	84
Desmarres Lid Retractor K-1101	31
Desmarres Scarifier for Lacrimal Sac K-2313	54
Dissectors & Scarifier	34
Disposable blades	119-124
Double Hook Nucleus Rotator & Iris Retractor K-1664	40
Drews Cystotome Cannula K-2260	107
Drews Irrigating Vectis K-2246	108
Drysdale Nucleus Rotator K-1866	41

E

Elliot Scleral Trophine & Handle K-1900	57
Ellis Foreign Body Spud K-1520	35
Elsching Cyclodialysis Spatula K-1706	43
Elsching Fixation Forceps K-2546	67
Enucleation Scissors K-3031	92
Erhardt Lid Forceps K-2926	84
Ernest Nucleus Cracker K-2838	82
Ernest Nucleus Cracker KT-2838	8
Equipment	126-136
Eye Dressing Forceps Serrated, Full Curved K-2502	63
Eye Dressing Forceps Serrated, Half Curved K-2501	63
Eye Dressing Forceps Serrated, Straight K-2500	63
Eye Scissors 5" Blunt K-3011	90
Eye Scissors 5" Pointed K-3009	89
Eye Shields K-3604	116

F

Faulkner Lens Folding Forceps K-2681	76
Faulkner Lens Holding Forceps K-2680	76
Feaster Lens Holding Forceps K-2682	76

Fenzl Lens Insertion Hook & Manipulator K-1648	39
Fichman Suturing & Cutting Forceps K-2565	70
Fink Lacrimal Sac Retractor K-1617	30
Fishkind-Castrovicjo Lid Speculum Open Blades K-1032	24
Fixation Forceps 4.25" K-2550	67
Fixation Forceps 4.25" K-2551	67
Fukasaku KT-1757	4
Fine Inserting Forceps KT 2840	7
Fixation Forceps 4.50" K-2549	67
Flexible Rule, Stainless Steel K-2000	51
Fleringa Scleral Fixation Rings K-1113	33
Forceps	61 83
Fox Eye Shield K-3604/1	116
Francis Foreign Body Spud K-1523.....	35
Freer Bone Chisel For Lacrimal Sac Curved K-2408	55
Freer Periosteal Elevator Double End Sharp & Blunt K-2407	55

G

Gasz Corneoscleral Punch K-2415	58
Gills Capsule Polishing Curette K-1822	50
Gills Irrigating Aspirating Cannula K-2227	106
Gills Vannas Capsulotomy Scissors K-3047	94
Gills-Welsh Lens Loop K-1634	47
Gills-Welsh Lens Loop With Olive Tip Probe Double End K-1635	47
Gills-Welsh Vannas Capsulotomy Scissors K-3046	94
Girard Corneal Scleral Forceps K-2566	70
Globe Fixation Ring For Prk and Lasik K-5101	14
Glaucoma Probe For Cryo Unit K-6014	135
Goldman Scleral Fixation Ring And Graefe Cataract Knife K-1300	34
Graefe Fixation Forceps K-2538	66
Graefe Iris Hook K-1600	37
Graefe Muscle Hook K-1622	36
Graefe Scarifier for Lacrimal Sac K-2312	54
Graether Collar Button Cannula K-2255	109
Graether Collar Button Iris Retractor K-1631	32
Grandon Irrigating Aspirating Cannula K-2228	106
Grandon T-Incision Marker K-5068	19
Grandon-Barraquer Wire Speculum K-1024	25
Green Fixation Forceps K-2545	67
Green Muscle Hook K-1625	36
Green Spatula Double End K-1724	44

H

Halsted Mosquito Forceps 3.25" K-2100	61
Halsted Mosquito Forceps 5.50" K-2101	61
Hammer For Dcr K-2412	56
Handles & Blades	125
Harms Collari Forceps KT-2648	5
Harms Collari Forceps K-2648	69
Harms Trabeculotomy Probe K-2315	53
Harms-Jaffe Tying Forceps KT-2642	6
Harms-Jaffe Tying Forceps K-2642	74
Hartmann Mosquito Forceps 3/25" K-2100	61
Healon Cannula K-2271	107
Heath Chalazion Forceps K-2928	84
Hebra Chalazion Curette K-1803	49
Hess Iris Forceps Swiss Model K-2524	64
Hirschman Lens Spatula For Iol Manipulation K-1636	38
Holth Corneoscleral Punch K-2410	60
Hoopes Combination Radial & T-Incision Hoskin Forceps	86-87
Hunkeler Lens Manipulator Angled K-1662	40
Hunt Chalazion Forceps K-2927	83
Hydro Dissection "J" Shaped Cannula K-2232	108
Hydro-Dissection Angled Cannula K-2233	108

I

Implants & Eye Shield	115
Infant Lacrimal Dilator Very Fine Blunt Tip K-2308.....	54
Intraocular Foreign Body Forceps Squeeze Handle K-2683.....	77
Intravitreal Probe For Cryo Unit K-6015	135
Irrigation Aspirations Handpiece K-2281	21
Irrigating Silicone Sееva K-2286	21
Iris Forceps 1 X 2 Teeth, Full-Curved K-2505	64
Iris Forceps 1 X 2 Teeth, Half-Curved K-2504	63
Iris Forceps 1 X 2 Teeth, Straight K-2503	63
Iris Retractors	32
Iris Scissors 4 1/2" K-3005	88
Iris Scissors 4 1/8" K-3003	88
Irrigating Cystotome Angled K-2262	107
Irrigating Cystotome Formed K-2267	107
Irrigating Cystotome Straight K-2263	107
Irrigating Aspiration Unit (Electric) K-6005	130

J

Jaeger Spatula, All Metal K-1104	33
Jaffe Lid Retractors K-1108	31
Jaffe Stitch Scissors K-3128	95
Jaffe-Knolle Iris Hook K-1651	37
Jameson Muscle Hook K-1620	38
Jayme Anterior Chamber Maintainer K-2288	108
Jensen Capsule Polisher Cannula K-2241	109
Joss Fixation Forceps K-2542	86
Jewelers Bipolar Forceps K-2935	85
Jewelers Forceps K-2616	72
Johnsons Ptosis Knife K-1452	34
Jones Towel Clamp K-2106	62
Joseph Periosteal Elevator K-2106	55

K

Kalt Needle Holder K-3202	99
Kansas Infusion Handle 3" K-2275	107
Kansas Lens Loop Serrated 3mm Wide K-1740	48
Kansas Nucleus Cleaver K-1742	48
Kansas Nucleus Fragment Forceps K-2810	78
Kansas Nucleus Trisector K-1741	48
Kansas Nucleus Vectis Solid K-1743	48
Kansas Radial Marker K-5060	18
Katzin Corneal Transplant Scissors K-3109/A	97
Katzin Micro Corneal Scissors K-3109	97
Kellan Hydro-Dissection Cannula K-2235	108
Kelman Cystotome Cannula K-2256	111
Kelman Cystotome Cannula K-2257	111
Kelman Cystotome Dowce K-2258	107
Kelman-McPherson Forceps K-2626	73
Kelley Decemets Membrane Punch	58
Keratometer K-6003	128
Kerrison Bone Rongeur K-2402	60
Khosla Hand Cautery With 2 Burners & Extension Tube For Extra Cell	51
Khosla Illuminated Trial Lens Set K-3500	112
Khosla Instrument Sterilizing Case K-4000	117-118
Khosla Mini Non-Illuminated Trial Lens Set (Plastic Rim) K-3501/B	114
Khosla Needle Holder Very Delicate Jaws K-3248	102
Khosla Non-Illuminated Trial Lens Set (Plastic Rim) K-3501/A	113

Khosla Non-Illuminated Trial Lens Set K-3501	112
Kirroy Lens Loop & Muscle Hook K-1736	46
Knapp Iris Scissors 4 1/2" K-3007	89
Knapp Lacrimal Sac Retractor K-1654	30
Knapp Spatula & Hook K-1728	44
Knapp Strabismus Scissors K-3015	90
Knives	14-34
Knolle Anterior Chamber Irrigating Cannula K-2230	107
Knolle Posterior Capsule Polisher Cannula K-2243	109
Knolle-Pearce Irrigating Vectis K-2245	109
Koch Nucleus Divider KT-1758	4
Koch Universal lens Folder K-2541	81
Koch Universal lens Folder KT-2541	8
Kraff Capsule Tag Forceps K-2684	77
Kratz Aspirating Speculum KT-1064	2
Kratz Capsule Polisher Cannula K-2242	109
Kratz Cystotome Cannula K-2217	107
Kratz-Barraquer Wire Speculum K-1043	25
Kremer Corneal Fixation Forceps K-5061	19
Kuglen Iris Hook & Lens Manipulator KT-1656	3
Kuglen Iris Hook & Lens Manipulator, Clover Leaf Tip KT-1637	3
Kuglen Iris Hook & Lens Manipulator, Clover Leaf Tip K-1637	38
Kuglen Iris Hook & Lens Manipulator, Push Pull Model K-1656	38
Kuhnt Corneal Scarifier K-1449	34
Kuhnt Fixation Forceps K-2547	67

L

La Force Foreign Body Spud K-1522	35
Lasik Spatula Double-ended K-5106	15
Lasik Flap Forceps K-5108	15
Lasik Flap Irrigator K2298	111
Lasik Irrigating Cannula K2299, k2212	111
Lacrimal Cannula K-2203	104
Lacrimal Instruments	53-56
Lacrimal Sac Retractors	29-30
Lambert Chalazion Forceps K-2922	83
Lancaster Eye Speculum K-1008	23
Lang Lacrimal Sac Dissector Double End K-2311	54
Lens Loops	45-47
Lens Manipulators & Iris Hooks	37-40
Lensometer K-6004	129
Lester Fixation Forceps K-2552	67
Lester Lens Manipulator, Modified Vaultec Shank K-1661	40

Lester Lens Manipulator K-1661	40
Lester Lens Manipulator K-1640	39
Lester Lens Manipulator KT-1640	3
Lewicky Lens Manipulator KT-1658	3
Lewicky Lens Manipulator K-1658	39
Lewicky Anterior Chamber Maintainer K-2287	108
Lewis Lens Loop K-1733	46
Lieberman Micro Finger KT-1764	4
Lieberman Micro Finger K-1764	42
Lid Retractors	8
Limis Forceps K-2615	73
Livernois Iol Holding & Holding Forceps KT-2829	7
Livernois Iol Holding Forceps KT-2830	7
Livernois Iol Holding Forceps K-2830	80
Livernois Iol Holding & Holding Forceps K-2829	80
Lordan Chalazion Forceps K-2930	84
Luntz-Dodick Trabulectomy Punch	58

M

Maloney Nucleus Rotator K-1663	40
Maloney Intra-Operative Keratometer KT-5103	15
Maltzman-Fenzl Lens Manipulator K-1859	39
Manhattan Eye & Ear Fixation Forceps K-2612	68
Maskel Capsulorhexis Forceps KI-2828	9
Maskel Capsulorhexis Forceps K-2828	79
McCullough Utility Forceps Serrated K-2532	65
McGuire Corneal Scissors K-3035	93
McIntyre Infusion Handle 3" K-2276	107
McIntyre Lacrimal Cannula K-2220	104
McIntyre Wire Speculum K-1025	25
McNeill-Goldman Scleral Fixation Ring	
McPherson Bipolar Forceps K-2932	85
McPherson Bipolar Forceps K-2933	85
McPherson Corneal Forceps K-2617	73
McPherson Corneal Forceps KT-2617	8
McPherson Corneal Forceps KI-2618	6
McPherson Needle Holder K-3231	102
McPherson Tying Forceps K-2618	73
McPherson-Westcott Stitch Scissors K-3130	95
Mendez Degree Gauge K-5001	16
Mendez Multi-Purpose Lasik Forceps K-5107	16
Meyhoefer Chalazion Curette K-1805	49
Membrane Scratcher k-1761	13
Membrane peeler k-1762	13
Membrane Spatula k-1763	13
Moorfield Suture Forceps K-2613	70
Mueller Lacrimal Sac Retractor K-1037	29

Mules Sphere Acrylic Implants K-3802	115
Muscle Hooks	36
Micro Needle Holder KT-3245	10

N

Nasal Speculum K-1055	56
Nasal Speculum K-1058	1
Nasal Speculum K-1058	27
Nasal Solid Blade Speculum 1060	27
Nasal Speculum K-1055	28
Nasal Speculum K-1055	56
Nasal Speculum K-1062	2
Nasal Speculum K-1082	28
Nagahara Phaco Chopper KT-1756	4
Needle Holder Very Delicate Jaws K-3243	102
Needle Holders	98-102
Neumann Depth Incision Gauge K-5032	18
Neumann OShepard Oval Optical Centre Marker K-5023	17
Nevyas k-1056	26
Nevyas k-1057	26
New Orleans Lens Loop K-1709	45
Nowell Lid Retractors K-1109	31
Nicati Capsule Polishing Curette K-1820	50
Noyes Iris Scissors K-3038	93
Nucleus Rotators	41
Nucleus Splitters	48
Nucleus sustainer 1765	4
Nucleus sustainer 1765	42

O

O'Connor Tenotomy Hook K-1824	36
O'Gawa Tying Forceps KT-2668	6
O'Gawa Tying Forceps K-2668	74
Operating Microscope With Nikon Head K-6001	126
Osher Y Hook Lens Manipulator K-1660	40

P

Pagenstecher Eye Spoon K-1802	49
Park Eye Speculum K-1028	23

Paton Spatula & Spoon K-1732	46
Paton Spatula & Spoon K-1732	15
Pettigrove k-5099	15
Perce Olive Tip Capsule Polisher K-2291	109
Peyman Silicone Oil Cannula K-2294	109
Pierse Corneal Forceps K-2657	70
Pierse Corneal Colibri Forceps K-2656	70
Pierse-Hoskin Fine Beaked Colibri Forceps K-3721	87
Pierse-Hoskin	86-87
Pierse-Hoskin Fine Beaked Fixation Colibri Forceps K-3723	87
Pre-Chopper KT-2636	8
Pre-Chopper K-2836	82
Pre-Chopper For Soft Cataracts KT-2837	8
Pre-Chopper For Soft Cataracts K-2837	82
Pierse-Hoskin Fine Beaked Micro Colibri Forceps K-3722	87
Pierse-Hoskin Fine Forceps K-3711	86
Pierse-Hoskin Fixation Forceps K-3710	86
Pierse-Hoskin Large Forceps K-3713	86
Pierse-Hoskin Micro Forceps K-3715	86
Pierse-Hoskin Skeletone Fine Forceps K-3718	87
Pierse-Hoskin Skeletone Fixation Forceps K-3720	87
Pierse-Hoskin Skeletone Micro Forceps K-3719	87
Pierse-Hoskin Suture Forceps K-3717	87
Pigtail Probe K-2306	53
Pisacano Nucleus Rotator K-1667	41
Polack Double Corneal Forceps K-2652	69

R

R.K. Instruments	14-21
Rainin Micro Iris Hook K-1653	37
Randolph Cyclodialysis Cannula K-2206	104
Retinal Membrane K-1759	13
Reninal Spatula K1760	13
Retinal Probe For Cryo Unit K-6013	135
Rizzuti Iris Retractor And Lens Expressor K-1116	32
Roger Iris Retractor K-1123	32
Rolf Probe For Lacrimal Sac K-2305	53
Rollet Lacrimal Sac Retractor K-1607	30
Rollet Ruginé For Lacrimal Sac K-2411	56
Rongeurs	59-60
Rosen Phaco Chopper KT-1739	4
Rosenbaum-Drews Iris Retractor K-1115	32
Rust Ring Remover	51

S

Sauer Eye Speculum K-1019	24
Sauer Fixation Forceps 1 X 2 Teeth K-2611	68
Schopons Orbital Retractor K-1117	33
Schepens Scleral Depressor With Thimble K-1112	33
Schiotz Tonometer K-0100	117
Schmidt-Rimpler Fixation Forceps K-2541	66
Schocket Scleral Depressor Double Ended K-1111	33
Scissors	88-98
Scleral Depressors	33
Shaaf foreign Body Forceps K-2817	78
Sheets Irrigating Vectis K-2247	109
Shepard Iol Forceps K-2640	75
Shepard Iris Hook K-1838	37
Shepard Optical Centre Marker K-5018	17
Shepard Radial Keratotomy Incision Simcoe Cortex Extractor & Capsule Polisher Cannula K-2239	109
Simcoe Cortex Extractor Cannula K-2216	109
Simcoe Irrigating Aspirating Cannula K-2218	105
Simcoe Irrigating Lens Nucleus Loop K-2249	110
Simcoe Lens Nucleus Loop Serrated, Double End K-1737	46
Simcoe-Barraquer Wire Speculum K-1045	25
Sinskey Lens Manipulator K-1633	38
Sinskey Tying Forceps K-2844	74
Sinskey 11 Iris Iol Hook KT-1632	3
Slit Lamp K-6002	127
Smith Lens Expressor & Loop Double End K-1621/A	47
Smith Lens Expressor K-1621	47
Snellen Entropium Forceps K-2917	83
Snelten Lens Loop K-1708	45
Solid Blade Speculum KT-1060	1
Spatulas	43-45
Speculums	22-25
Spencer Stitch Scissors, 3.5" K-3030	92
Spivey Iris Retractor K-1615	32
Spoons	48-49
Spuds	35
St. Martin Suture Forceps K-2608	71
Steinert Universal Folding Forceps KT-2839	7
Sterilizing Trays	117
Stern-Gills Scissors K-3049	94
Stevens Needle Holder Straight K-3221	101
Stevens Tenotomy Hook K-1627	36
Stevens Tenotomy Scissors, New Model K-3022	91
Stevens Tenotomy Scissors Long Model K-3026	92
Stevens Lacrimal Sac Retractor K-1036	29

Strabismus Scissors K-3013 90
 Strabismus Scissors Probe Point K-3017 91
 Swiss Model Breaker & Holder K-3219 103

T

Tennant Colibri Forceps K-2650 69
 Tennant Lid Retractors K-1110 31
 Tennant Nucleus Rotator Ball Tip K-1668 41
 Tennant Tying Forceps K-2646 74
 Temporal Speculum KI-1069 1
 Temporal Speculum KT-1063 2
 Thornton Low Profile Globe Fixation Ring K-5000 14
 Thornton K-5040 17
 Thorpe Corneal & Splinter Forceps K-2818 79
 Titanium Instruments 1-12
 Took Corneal Knife K-1439 34
 Trephines 57
 Trial Lens Sets 112-113
 Triple Marker K-5073 18
 Troutman Lens Loop K-1445 45
 Troutman Lens Spatula K-1446 45
 Troutman Superior Rectus Forceps K-2555 88
 Troutman-Barraguer Iris Spatula K-1444 43
 Troutman-Castroviejo Comeoscleral Scissors K-324/B 95
 Troutman-Castroviejo Micro Corneal Scissors K-324 98
 Troutman-I lobera Fixation Forceps K-2544 66
 Tying Forceps Without Teeth K-2602 81

U

"U" Shaped Cannula For Phaco Port K-2237 108
 Ubra-Stern Scissors K-3050 94
 Universal Conformer K-3603 115
 Universal Eye Shield K-3605/4 116
 Universal Reversible Speculum K-1061 1
 Utility Forceps 4" 1 X 2 Teeth, K-2531 64
 Utility Forceps 4" Serrated, K-2530 64
 Utrata Capsulorhexis Forceps K-2834 80
 Utrata Capsulorhexis Forceps K-2835 80
 Utrata Capsulorhexis Forceps KT-2834 9
 Utrata Capsulorhexis Forceps KT 2835 9
 Utrata Capsulorhexis Forceps K-2826 97

V

Vannas Capsulotomy Scissors K-3042 94
 Viscoclastic Aspirating Cannula K-2221 104
 Vitrectomy Unit (Electric) K-6006 130
 Vitrectomy Unit (Gas Operated) K-6007 131
 Vitreoretinal Instrument 11-13

W

Waldau Fixation Forceps K-2540 66
 Weber Lens Loop K-1714 45
 Wecker Iris Spatula K-1700 43
 Weiss Eye Speculum K-1002 22
 Weiss Eye Speculum K-1015 23
 Wells Enucleation Spoon K-1716 48
 Welsh Flat Olive Tip Cannula K-2211 104
 Welsh Model OF Simcoe Cortex Extractor Cannula K-2214 109
 West Bone Chisel For Lacrimal Sac Straight K-2404 55
 West Bone Gouge For Lacrimal Sac Straight K-2405 55
 Westcott Tenotomy Scissors K-3100 95
 Wilder Lacrimal Dilator K-2307 54
 Wilder Lens Loop Serrated K-1735 46
 Williams Eye Speculum K-1004 22
 Wills Eye Hospital Foreign Body Spud & Burr K-1524 35
 Wills Hospital Cautey K-1815 50
 Wills Hospital Utility Forceps Serrated K-2534 66

Y

Youens Lens Manipulating Cannula K-2254 97

Z

Ziegler Cilia Forceps K-2705 77
 Ziegler Probe For Lacrimal Canal K-2304 53

CAT. NO. PAGE NO.

K-1001	22
K-1002	22
K-1004/1	22
K-1004/2	22
K-1006	22
K-1008	23
K-1013/1	23
K-1013/2	23
K-1015/1	23
K-1015/2	23
K-1019/1	24
K-1019/2	24
K-1019/3	24
K-1020/00	24
K-1020/0	24
K-1020/1	24
K-1020/2	24
K-1020/3	24
K-1020/4	24
K-1020/R	26
K-1021/0	24
K-1021/1	24
K-1021/2	24
K-1021/3	24
K-1021/4	24
K-1024/A	25
K-1024/B	25
K-1025	25
K-1025/A	25
K-1028	23
K-1031/1	24
K-1031/2	24
K-1031/3	24
K-1032	24
K-1037	29
K-1038	29
K-1039	29
K-1043/1	25
K-1043/2	25
K-1045/A,B	25
K-1043/IR	26
K-1043/ZR	26
K-1049/1	23
K-1049/2	23

CAT. NO. PAGE NO.

K-1049/3	23
K-1050/1	23
K-1050/2	23
K-1055/1,2,3	56
K-1056	26
K-1057	26
K-1058	27
KT-1058	1
K-1059	27
KT-1059	1
KT-1060	1
K-1060	27
KT-1061	1
K-1061	27
KT-1062	2
K-1062	28
K-1063	28
KT-1063	2
K-1064	28
K-1101/0	31
K-1101/1	31
K-1101/2	31
K-1101/3	31
K-1101/4	31
K-1104	33
K-1108/1	31
K-1108/2	31
K-1109	31
K-1110	31
K-1111	33
K-1112/1	33
K-1112/2	33
K-1112/3	33
K-1113	33
K-1115	32
K-1115/L	32
K-1115/R	32
K-1116	32
K-1123S	32
K-1123/L	32
K-1123/R	32
K-1147/1	34
K-1300/1	34
K-1300/2	34

CAT. NO. PAGE NO.

K-1300/3	34
K-1300/4	34
K-1300/5	34
K-1417/1,2	34
K-1417/3	34
K-1439	34
K-1444	43
K-1445	45
K-1446	45
K-1449	34
K-1452	34
K-1455	47
K-1515	35
K-1522	35
K-1523	35
K-1524	35
K-1600	37
K-1601	37
K-1607	30
K-1608	30
K-1613	30
K-1614	30
K-1615	32
K-1620/1	36
K-1620/2	36
K-1621	47
K-1621/A	47
K-1622/1	36
K-1622/2,3	36
K-1624	36
K-1625	36
K-1626	36
K-1627	36
K-1628	36
K-1631/S	32
K-1631/A	32
K-1631/B	32
K-1631/C	32
KT-1632	3
K-1632	38
KT-1633	3
K-1633	38
K-1634	47
K-1635	47

CAT. NO. PAGE NO.

K-1636	38
K-1637/S	38
K-1637/A	38
KT-1637/S,A	3
K-1638	37
K-1639	37
KT-1640/S,A	3
K-1640/S	39
K-1640/A	39
KT-1644/1,2	3
K-1644/1	41
K-1644/2	41
K-1647/S	39
K-1647/A	39
K-1648/S	39
K-1648/A	39
K-1651/S	37
K-1651/A	37
K-1654/1	30
K-1654/2	30
KT-1656/S,A	3
K-1656/A	38
K-1656/S	38
KT-1658	3
K-1658	39
K-1659/S	39
K-1659/A	39
K-1660	40
K-1661	40
K-1662	40
K-1663	40
K-1664	40
K-1665	41
K-1666	41
K-1667	41
K-1668	41
K-1700/1	43
K-1700/2	43
K-1703	43
K-1704/1	43
K-1704/2	43
K-1706	43
K-1707	45
K-1708	45

CAT. NO. PAGE NO.

K-1709	45
K-1714/1	45
K-1714/2	45
K-1716	48
K-1717	33
K-1722	44
K-1722/A	44
K-1723	44
K-1724/1	44
K-1724/2	44
K-1728	44
K-1732	46
K-1732	15
K-1733/1	46
K-1733/2	46
K-1735	46
K-1736	46
K-1737	46
KT-1739	4
K-1739	42
K-1740	48
K-1741	48
K-1742	48
K-1743	48
K-1752	51
K-1755	51
K-1755/A	51
K-1755/B	51
KT-1756	4
K-1756	42
KT-1757	4
K-1757	42
KT-1758	4
K-1758	42
K-1759	13
K-1760	13
K-1761	13
K-1762	13
K-1763	13
KT-1764	4
K-1764	42
KT-1765	4
K-1765	42
K-1802	49

CAT. NO. PAGE NO.

K-1803/1	49
K-1803/2	49
K-1803/3	49
K-1804	49
K-1805/1	49
K-1805/2	49
K-1805/3	49
K-1805/4	49
K-1808/1	49
K-1808/2	49
K-1808/3	49
K-1808/4	49
K-1808/5	49
K-1810	50
K-1815	50
K-1816	50
K-1820	50
K-1822	50
K-1823	50
K-1900	57
K-1900/A	57
K-1900/B	57
K-1900/C	57
K-1901	57
K-1902	57
K-1903	57
K-2000	51
K-2002/S	52
K-2002/C	52
K-2003/S	52
K-2003/C	52
K-2100/S	61
K-2100/C	61
K-2101/S,C	61
K-2103	61
K-2103	61
K-2105/1	62
K-2105/2	62
K-2106	62
K-2200	104
K-2201	104
K-2202	104
K-2203/S	104
K-2203/C	104

CAT. NO. PAGE NO.

K-2203/S	104
K-2203/C	104
K-2205/A	104
K-2205/B	104
K-2205/C	104
K-2211/L	104
K-2211/R	104
K-2212	111
K-2214	109
K-2215	13
K-2216/1	109
K-2217	107
K-2218	105
K-2218/A	105
K-2218/RC	105
K-2218/LC	105
K-2219	106
K-2219/A	106
K-2219/B	106
K-2219/C	106
K-2220/S	104
K-2220/C	104
K-2221/A	104
K-2221/B	104
K-2221/S	104
K-2222	105
K-2223/A	104
K-2223/B	104
K-2223/C	104
K-2227	106
K-2228	106
K-2230/1	107
K-2230/2	107
K-2232	108
K-2233/1	108
K-2233/2	108
K-2235/1	108
K-2235/2	108
K-2236	108
K-2237/1	108
K-2237/2	108
K-2239/1	109
K-2239/2	109
K-2241/1	109

CAT. NO. PAGE NO.

K-2241/2	109
K-2242/1	109
K-2241/2	109
K-2243/1	109
K-2243/2	109
K-2245	109
K-2246	109
K-2247	110
K-2248	110
K-2249/R	110
K-2249/L	110
K-2255/S	109
K-2255/A	109
K-2256	111
K-2257	111
K-2258	107
K-2260/1	107
K-2260/2	107
K-2262	107
K-2263/1	107
K-2263/2	107
K-2263/3	107
K-2263/4	107
K-2264/A	111
K-2264/C	111
K-2265/A	111
K-2265/C	111
K-2266	111
KT-2273	20
KT-2273	20
KT-2274	20
K-2267/1	107
K-2267/2	107
K-2267/3	107
K-2267/4	107
K-2268	111
K-2271	107
K-2273	20
K-2275	107
K-2276	107
K-2278	108
KT-2279	20
KT-2280	20
K-2281/S,C	21

CAT. NO. PAGE NO.

K-2281/45°90°	21
K-2281/SI	21
K-2281/B	21
K-2282/15	21
K-2282/30	21
K-2282/45	21
K-2283	21
K-2283	21
K-2285	21
K-2286	21
K-2287	108
K-2288	108
K-2289	108
K-2290/L	108
K-2290/R	108
K-2291	109
K-2292	110
K-2293/A	110
K-2293/B	110
K-2293/C	110
K-2294	110
K-2295/S	110
K-2295/C	110
K-2296/S	110
K-2296/A	110
K-2297/S	110
K-2297/C	110
K-2298	111
K-2299/1	111
K-2299/2	111
K-2300	53
K-2304	53
K-2305	53
K-2306/A	53
K-2306/B	53
K-2306/C	53
K-2307/1	54
K-2307/2	54
K-2307/3	54
K-2308	54
K-2309	54
K-2310	54
K-2311	54
K-2312	54

CAT. NO. PAGE NO.

K-2313	54
K-2315/L	53
K-2315/R	53
K-2400	59
K-2401	59
K-2402/1	60
K-2402/2	60
K-2402/3	60
K-2403	60
K-2404	55
K-2405	55
K-2406	55
K-2407	55
K-2408	55
K-2409/1	56
K-2409/2	56
K-2410/1	60
K-2410/2	60
K-2410/3	60
K-2411	56
K-2412	56
K-2413	58
K-2413/A	58
K-2415S/A	58
K-2415S/B	58
K-2415S/C	58
K-2415	58
K-2455/1	56
K-2455/2	56
K-2455/3	56
K-2500	63
K-2501	63
K-2502	63
K-2503	63
K-2504	63
K-2505	64
KT-2517/A	5
K-2517/A	64
K-2517/B	64
K-2518	64
K-2523	71
K-2524	64
K-2530	64
K-2531	64

CAT. NO. PAGE NO.

K-2532	65
K-2533	65
K-2534	65
K-2535	65
K-2536	65
K-2538	66
K-2540	66
K-2541	66
K-2542	66
K-2543	66
K-2544	66
K-2545/1	67
K-2545/2	67
K-2546	67
K-2547	67
K-2549	67
K-2550	67
K-2551	67
K-2552/1	67
K-2552/2	67
K-2554	68
K-2555	68
K-2556/S	68
K-2556/A	68
K-2560	68
K-2566/1	70
KT-2562/A,B	5
K-2562/A	71
K-2562/B	71
K-2562/C	71
K-2563/A	71
K-2563/B	71
KT-2564	5
K-2564	71
K-2566/1,2	70
KT-2601	5
K-2600	69
K-2601	69
KT-2602	5
K-2602	74
K-2603	71
K-2604	71
K-2605	71
K-2608	71

CAT. NO. PAGE NO.

K-2611	68
K-2612	68
K-2613	70
K-2615	73
K-2616/1	72
K-2616/3	72
K-2616/3C	72
K-2616/4	72
K-2616/5	72
K-2616/5A	72
K-2616/7	72
KT-2617	6
K-2617	73
KT-2618	6
K-2618	73
K-2619	73
K-2620	73
K-2625	73
KT-2626	6
K-2626	73
KT-2627	7
K-2627	75
K-2630	76
K-2631	76
K-2634	75
K-2640	75
K-2641	75
KT-2642/S,C	6
K-2642/S,C	74
K-2642/C	74
K-2644/S	74
K-2644/C	74
K-2646/S	74
K-2646/C	74
KT-2648	5
K-2648	69
KT-2649	5
K-2649	69
K-2652	69
K-2656/1	70
K-2656/2	70
K-2657/1	70
K-2657/2	70
K-2660	69



index

CAT. NO. PAGE NO.

KT-2662	6
K-2662	73
KT-2668/S	6
K-2668/S	74
KT-2668/C	6
K-2668/C	74
K-2676	75
K 2680	76
K-2681	76
K-2682	76
K-2684	77
KT-2685	11
K- 2685	11
KT-2686	11
K 2686	11
KT-2687	11
K- 2687	11
KT-2688	11
K-2688	11
KT-2689	11
K- 2689	11
KT-2690	11
K- 2690	11
KT-2691	11
K- 2691	11
K- 2692	11
K-2703	77
K-2704	77
K-2705	77
K-2804	78
K-2805	78
K-2810	78
K-2817	78
KT-2826	9
K-2826	79
KT-2827	9
K-2827	79
KT-2828	9
K-2828	79
KT-2829	7
K-2829	80
KT-2830	7
K-2830	80
KT-2831	7

CAT. NO. PAGE NO.

K-2831	80
KT-2832	7
K 2832	80
K-2833	81
KT-2834	9
K-2834	80
KT-2835	9
K-2835	80
K-2835	80
KT-2836	8
K-2836/A,S	82
KT-2836	8
K-2836/A	82
K-2837/S	82
KT 2837/C	8
K-2837/C	82
KT-2837/S	8
KT-2837/A	8
K-2837/A	82
KT-2838	8
K-2838	82
KT-2839	7
K-2839	81
KT-2840	7
K-2840	81
KT-2841	8
K-2841	81
K 2916	83
K-2917/R	83
K-2917/L	83
K-2920	83
K-2921	83
K-2922	83
K-2923/0	84
K 2923/1	84
K-2923/2	84
K-2923/3	84
K-2926	84
K-2927	83
K-2928	84
K-2930	84
K-2931	85
K-2932/S	85
K-2932/A	85

CAT. NO. PAGE NO.

K-2934	85
K-2935	85
K-3000	88
K 3001/C	88
K-3002/A	88
K-3003/S	88
K-3004/C	88
K-3005/S	88
K 3006/C	88
K-3007/S	89
K-3007/C	89
K-3008/S	89
K-3008/C	89
K-3009	89
K-3010	89
K 3011	90
K-3012	90
K-3013	90
K-3014	90
K-3015	90
K-3016	90
K-3022	91
K-3023	91
K-3024	91
K-3025	91
K-3026	91
K-3027	91
K-3028	91
K 3029	91
K-3030	91
K-3031	92
K-3032	92
K-3033	92
K-3034	92
K-3035	93
K-3036	93
K-3037/A	93
K-3037/B	93
K-3037/C	93
K-3038/A	93
K 3038/B	93
K-3038/C	93
K-3040	93
K-3041	93

CAT. NO. PAGE NO.

K-3042	94
K-3043	94
K-3045	94
K-3046	94
K-3047	94
K-3048	94
K-3049	94
K-3050	94
K-3100	95
K-3100/A	95
K-3101	95
K-3101/A	95
K-3103	96
K-3104	96
K-3105	96
K-3106	96
K-3107	96
K-3108	97
K-3109	97
K-3109/A	97
K-3110	97
K-3110/B	97
K-3115	97
K-3116	97
K-3117	97
K-3118	98
K-3119	98
K-3124	98
K-3124/A	98
K-3124/B	98
K-3125	98
K-3125/A	98
K-3125/B	98
K-3128	95
K-3130/A	95
K-3130/B	95
KT-3137	12
K-3137	12
KT-3138	12
K-3138	12
KT-3139	12
K-3139	12
KT-3140	12
K-3140	12

CAT. NO. PAGE NO.

K-3141	12
KT-3142	12
K-3142	12
KT-3143	12
K-3143	12
K-3200	99
K-3201	99
K-3202	99
K-3203	99
K-3204	99
K-3205	99
K-3206	100
K-3207	100
K-3208	100
K-3209	100
KT-3210/A	10
K-3210/A	101
KT-3210/B	10
K-3210/B	101
K-3211/A	101
K-3211/B	101
K-3212/A	101
K-3212/B	101
K-3213/A	101
K-3213/B	101
K-3216	103
K-3217	103
K-3219	103
K-3220	103
K-3221/A	102
K-3221/B	102
K-3223	103
K-3227/SA	100
KT-3227/CB	10
K-3227/SB	100
K-3227/CA	100
K-3227/CB	100
K-3228/SA	100
K-3228/SB	100
K-3228/CA	100
K-3228/CB	100
K-3231/A	102
K-3231/B	102
K-3232/A	102

CAT. NO. PAGE NO.

K-3232/B	102
K-3240/A	101
K-3240/B	101
K-3241/A	101
K-3241/B	101
K-3243/A	102
K-3243/B	102
K-3234/A	102
K-3243/B	102
KT-3245	10
K-3500	112
K-3501	112
K-3501/A	113
K-3501/B	114
K-3502	114
K-3555/1	125
K-3600/1	115
K-3600/2	115
K-3600/3	115
K-3601	115
K-3602	115
K-3603	115
K-3604/1	116
K-3604/2	116
K-3604/3	116
K-3605	115
K-3605/4	116
K-3650/3	125
K-3650/4	125
K-3650/7	125
K-3651/2	125
K-3651/3	125
K-3651/4	125
K-3651/6	125
K-3651/4H	125
K-3655/1,2	125
K-3655/3	125
K-3710	86
K-3711	86
K-3714	86
K-3715	86
K-3716	86
K-3717	87
K-3718	87

CAT. NO. PAGE NO.

K-3719	87
K-3720	87
K-3721	87
K-3722	87
K-4000	117
K-4001	117
K-4002	117
K-4003-4013	118
K-5000	14
K-5000/A	14
K-5000/B	14
K-5000/C	14
K-5000/D	14
K-5001	16
K-5002	16
K-5005/A	16
K-5005	16
K-5006	16
K-5007	16
K-5008	16
K-5010	17
K-5011	17
K-5012	17
K-5013	17
K-5014	17
K-5015	17
K-5016	17
K-5017	17
K-5018	17
K-5019	17
K-5020	17
K-5021	17
K-5022	17
K-5023	17
K-5024	17
K-5025	17
K-5026	17
K-5027	17
K-5028	17
K-5029	17
K-5030	17
K-5032	16
K-5040	17
K-5041	17

CAT. NO. PAGE NO.

K-5042	17
K-5043	17
K-5044	17
K-5045	17
K-5046	17
K-5047	17
K-5048	17
K-5049	17
K-5050	17
K-5051	17
K-5052	17
K-5053	17
K-5061/S	19
K-5061/C	19
K-5062/S	19
K-5062/C	19
K-5063/S	19
K-5063/C	19
K-5068/1	19
K-5068/2	19
K-5068/3	19
K-5068/4	19
K-5068/5	19
K-5072	18
K-5073	18
K-5084	18
K-5085	18
K-5086	18
K-5087	18
K-5088	18
K-5089	18
K-5090	18
K-5091	18
K-5092	18
K-5093	18
K-5094	18
K-5095	18
K-5096	18
K-5097	18
K-5099	15
K-5100	15
K-5101	14
K-5102	14
KT-5103	15

CAT. NO. PAGE NO.

K-5104	14
K-5105	15
K-5106	15
K-5107	16
K-5108	16
K-6001	126
K-6002	127
K-6003	128
K-6004	129
K-6005	130
K-6006	130
K-6007	131
K-6008	132
K-6009	133
K-6010	133
K-6011	134
K-6012/C	135
K-6012/S	135
K-6013/C	135
K-6013/S	135
K-6014	135
K-6015	135
K-6016	136
K-6100	117
AK-921501	119-123

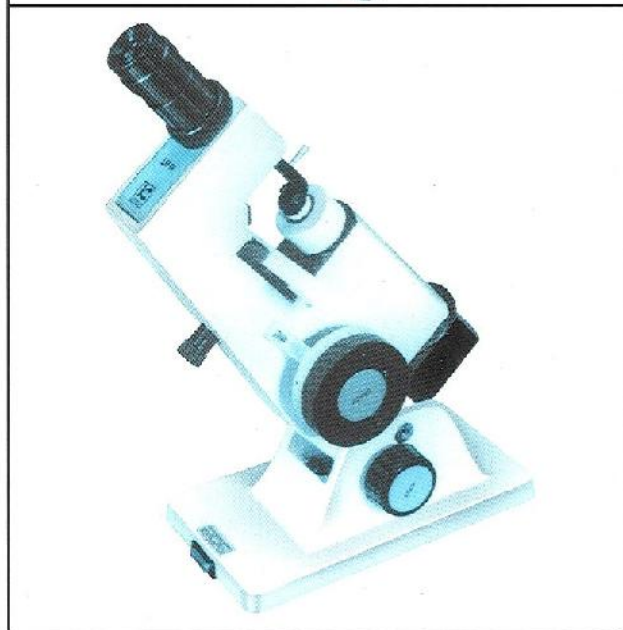
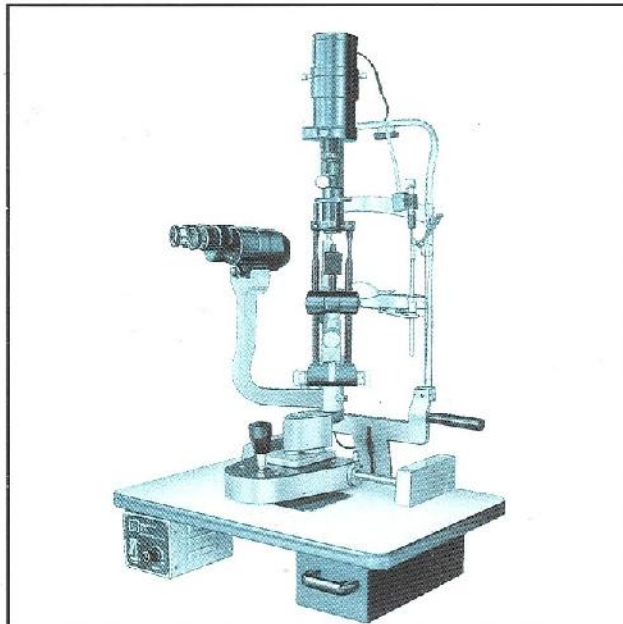

Khosla Eye Instruments

**M/S. KHOSLA SURGICAL INDUSTRIES
SUDESH BUILDING, KENNEDY BRIDGE, NANA CHOWK, MUMBAI 400 007.INDIA.**

TEL. NO.: 91-22-23875268 /23888603 FAX : 00-91-22-2380-5269

Email : khosla1@vsnl.com / neeru@khoslasurgicals.com

Website : www.khoslasurgicals.com